



OWNER'S MANUAL
RANGER • TOURIST • CT

imz-ural.com.au

Intentionally left blank

INTRODUCTION

Welcome to the URAL Motorcycling Family! Your Ural has been built by the Irbit Motorcycle Factory in Russia and distributed by the Australian affiliate of the Irbit Motorcycle Factory, Ural Australia Pty Ltd.

This Ural motorcycle conforms to all applicable Australian motor vehicle Design Rule (ADR) Standards effective on the date of manufacture.

This manual covers the Ranger, Tourist and cT models and has been prepared to acquaint you with the operation, care and maintenance of your motorcycle and to provide you with important safety information. Follow these instructions carefully for maximum motorcycle performance and for your personal motorcycling safety and pleasure. It is critical that a beginning sidecar driver becomes thoroughly familiar with the special operating characteristics of sidecar outfit before venturing out on the busy roads.

Your Owner's Manual contains instructions for operation, maintenance and minor repairs. Major repairs require the attention of a skilled mechanic and the use of special tools and equipment. Your Authorised Ural Dealer has the facilities, experience and genuine Ural parts necessary to properly render this valuable service.

Any suggestions or comments are welcome!

Happy Uraling!

Ural Australia Pty Ltd

119 Bridge Street
Uralla NSW 2358
Phone: +61 2 6778 4673
Email: info@imz-ural.com.au
Website: www.imz-ural.com.au

IMPORTANT SAFETY INFORMATION

WE STRONGLY SUGGEST THAT YOU READ THIS MANUAL COMPLETELY PRIOR TO RIDING YOUR NEW URAL MOTORCYCLE. THIS MANUAL CONTAINS INFORMATION AND ADVICE THAT WILL HELP YOU PROPERLY OPERATE AND MAINTAIN YOUR MOTORCYCLE. PLEASE PAY SPECIAL ATTENTION TO NOTICES IN THIS MANUAL MARKED AS FOLLOWS:

CAUTION

INDICATES POSSIBILITY OF EQUIPMENT FAILURE THAT MAY RESULT IN YOUR MOTORCYCLE BE UNSAFE TO OPERATE IF INSTRUCTIONS ARE NOT FOLLOWED

WARNING

INDICATES A VERY STRONG POSSIBILITY OF INJURY TO YOURSELF AND OTHERS OR LOSS OF LIFE IF INSTRUCTIONS ARE NOT FOLLOWED

NOTE

PROVIDES HELPFUL INFORMATION AND TIPS

Table of Contents

	Section
General Information	1
Motorcycle Controls and Instrumentation	2
Motorcycle Operation	3
Service & Maintenance Sections	
Lubrication	4
Engine & Chassis Maintenance	5
Electrical	6
EFI Troubleshooting	7
Consumer Information Sections	
Warranty Information	8
Emission Control Information	9
Owner Documents	10
Schematics	11

1. General Information

	Page
Service Rules	1-2
Model Identification	1-3
Model Specifications	1-4
Torque Chart	1-5
Clearance and Adjustment Specifications	1-6
Tire Data	1-6
Periodic Maintenance Chart	1-7
Motorcycle Storage and Care	1-8

SERVICE RULES

1. Always wear proper safety equipment including but not limited to safety glasses and gloves.
2. Allow your motorcycle to cool down completely prior to servicing to avoid getting burned.
3. Always use genuine Ural or Ural recommended parts, fluids and components when servicing your motorcycle. Parts that do not meet these requirements may result in damage.
4. Follow the service procedures as outlined in this manual.
5. Always follow the torque specifications when tightening nuts and bolts.
6. Clean all parts with non-flammable solvents prior to reassembly after servicing.
7. Always replace seals, O-rings, gaskets and cotter pins when reassembling.
8. If you remove self-locking nuts they should always be replaced with new ones.
9. Be responsible with solvents, cleaners and waste oils. Always dispose of them in accordance with your local regulations.

WARNING

IF THE ENGINE MUST BE RUNNING TO PERFORM A PARTICULAR SERVICE PROCEDURE BE SURE YOU ARE IN A WELL VENTILATED AREA. EXHAUST CONTAINS CARBON MONOXIDE GAS.

WARNING

GASOLINE IS VERY FLAMMABLE AND CAN BE EXPLOSIVE UNDER CERTAIN CONDITIONS. IT IS ALSO VERY HARMFUL TO THE SKIN AND EYES. DO NOT SMOKE OR ALLOW SPARKS IN OR NEAR YOUR WORK AREA.

MODEL IDENTIFICATION



VIN (Vehicle Identification Number)

The VIN label is located on the right hand frame down tube and is also stamped on the frame directly above the label.

List Your VIN Here

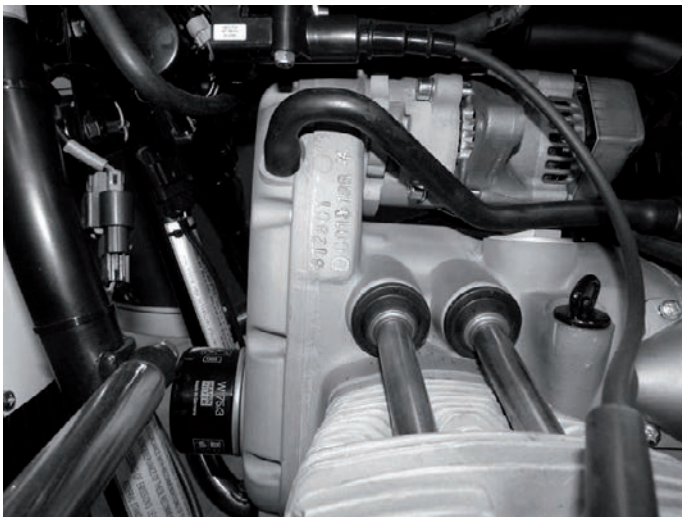

Engine Number

The engine number is stamped near the crankcase breather, it is the second number.

List Your Engine Number Here

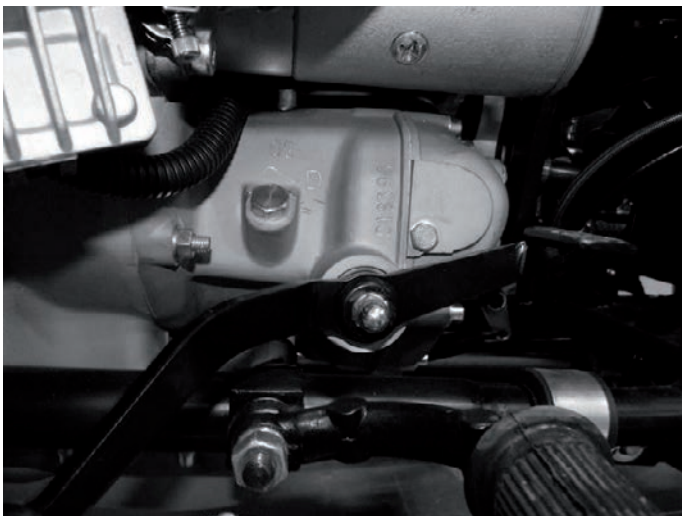

Gearbox Number

The gearbox number is stamped on the left side of the gearbox directly above the shift lever.

List Your Gearbox Number Here

MODEL SPECIFICATIONS

Model	cT	Patrol, Gear-Up
Engine and transmission		
Displacement, cc	749	749
Engine type	OHV air cooled 2 cylinder 4 stroke "boxer" (flat twin)	OHV air cooled 2 cylinder 4 stroke "boxer" (flat twin)
Valve per cylinder	2	2
Bore and stroke (mm x mm)	78 x 78	78 x 78
Max output (hp)	41 @ 5500 rpm	41 @ 5500 rpm
Max torque (ft-lbs)	42 @ 4300 rpm	42 @ 4300 rpm
Compression	8.6:1	8.6:1
Fuel system	Throttle body EFI	Throttle body EFI
Starting	Electric & Kick start	Electric & Kick start
Clutch	Double-disc dry	Double-disc dry
Transmission type	Manual	Manual
Speeds	4 forward 1 reverse	4 forward 1 reverse
Primary drive (rear wheel)	Driveshaft	Driveshaft
Final drive ratio	4.62	4.62
Engagable sidecar wheel drive	No	Yes, driveshaft
Physical measures		
Overall length, inch.	91.6	98.8
Overall heights, inch.	53.8	54.3
Overall width, inch.	63.6	63.6
Seat height, (unladen), inch.	31.0	32.0
Ground clearance (unladen), inch.	6.2	6.8
Dry weight, lbs	700	730
Chassis		
Front suspension	IMZ leading link fork	IMZ leading link fork
Rear suspension	Double sided swing-arm with two Sachs hydraulic spring shock absorbers, 5x adjustable	Double sided swing-arm with two Sachs hydraulic spring shock absorbers, 5x adjustable
Sidecar suspension	Single sided swing-arm with Sachs hydraulic spring shock absorber, 5x adjustable	Single sided swing-arm with Sachs hydraulic spring shock absorber, 5x adjustable
Wheels	2.15X18 Aluminum rims with steel spokes	2.15X19 Aluminum rims with steel spokes
Tires	Heidenau K28, 4.0x18"	Duro HF-308, 4.0x19"
Front brake	4-piston fixed Brembo caliper with 295mm floating NG rotor	4-piston fixed Brembo caliper with 295mm floating NG rotor
Rear brake	HB big bore single piston integrated floating caliper with 256mm fixed NG rotor	HB big bore single piston integrated floating caliper with 256mm fixed NG rotor
Sidecar brake	2-piston fixed Brembo caliper with 245mm floating NG rotor	2-piston fixed Brembo caliper with 245mm floating NG rotor
Other		
Fuel grade	91 Octane, unleaded	91 Octane, unleaded
Fuel tank capacity (gallons)	5.0	5.0
Reserve (gallons)	app. 1	app. 1
Estimated fuel economy, mpg	31-37	31-37
Estimated range, miles	155-185	155-185
Recommended max cruising speed (mph)	70	70
Max permissible weight, lbs	1325	1325
Trunk volume, cubic ft.	2.9	2.9
Electrical		
Alternator	Denso, Peak Output 40 Amp @ 14vdc, 560 Wt	Denso, Peak Output 40 Amp @ 14vdc, 560 Wt
Battery	FAYTX20HL (12V, 20A)	FAYTX20HL (12V, 20A)
Headlight	H6024 (65/35)	H6024 (65/35)
Spark plugs	NGK BPR6HS	NGK BPR6HS
Warranty	2-years parts and labor unlimited mileage	2-years parts and labor unlimited mileage

TORQUE SPECIFICATIONS

Chassis	Newton Meters	Foot Pounds
Fork Pinch Bolts (Upper and Lower Bridges)	50	36.9
Upper fork Nuts	30	22.1
Steering Head Nut	34	25.1
Front fork Upper Shock Bolts	49	36.1
Upper Shock Bolts	30	22.1
Lower Shock Bolts	49	36.1
Front and Rear Brake Caliper Bracket Bolts	50	36.9
Rear Caliper Mounting Bolts	50	36.9
Front Caliper Mounting Bolts	50	36.9
Sidecar Caliper Mounting Bolts	50	36.9
Front Brake Reaction Link	70	51.6
Brake Rotors	30	22.1
Rear Swing Arm Mounting Bolts	88	64.9
Sidecar Swing Arm Mounting Bolts	88	64.9
Front Fork to Pivot of Swing Arm Mounting Bolts	50	36.9
Lower Sidecar Frame Mounting Bolts	88	64.9
Sidecar Strut Mounting Bolts	88	64.9
Spoke Nipple	4 to 6	2.9 to 4.4
Drive Train		
Engine, Gearbox, and Final Drive Drain Plugs	22	16.2
Cylinder Head Nuts	50	36.9
Valve Cover Nuts	24	17.7
Oil Pump Drive Gear Cap Bolt	10	7.4
Final Drive to Swing Arm Mounting Nuts	35	25.8
Final Drive Case Nuts	24	17.7
Engine Sump	10	7.4
Alternator Mounting Nuts	22	16.2
Intake Flange Mounting Bolts	20	14.8
Exhaust Header Pipe Nuts	24	17.7
Exhaust Mounting Clamp Bolts	16	11.8
Drive Wheel Splines (Spline Flanges)	30	22.1

CLEARANCES

Location	Millimeters	Inches
Intake Valves (Cold)	.1	.004
Exhaust Valves (Cold)	.1	.004
Spark Plug Electrode	1.00	0.04
Minimum Tread Depth	3.175	0.125
Minimum Brake Pad Thickness	1	0.04

FREE PLAY & ADJUSTMENTS

Location	Millimeters	Inches
Front Brake Lever	5 to 8	.2 to .3
Clutch Lever	5 to 8	.2 to .3
Rear Brake Lever	1/4 of Full Travel	1/4 of Full Travel
Toe-In (1wd)	8 to 12	.3 to .475
Toe-In (2wd)	3 to 8	.125 to .315
Lean Out	1 to 2 degrees	1 to 2 degrees

TYRE DATA

Location	Type	Recommended PSI
Front	Duro H-308 (4.0x19) Heidenau K28 (4.0x18 cT only)	32 PSI Cold
Rear	Duro H-308 (4.0x19) Heidenau K28 (4.0x18 cT only)	36 PSI Cold
Sidecar	Duro H-308 (4.0x19) Heidenau K28 (4.0x18 cT only)	32 PSI Cold
Spare (if equipped)	Duro H-308 (4.0x19) Heidenau K28 (4.0x18 cT only)	36 PSI Cold
Optional Knobby Tires	Duro H-308 (4.0x19)	Per location on bike

WARNING

IMPROPER TYRE INFLATION WILL CAUSE ABNORMAL TREAD WEAR AND COULD RESULT IN UNSTABLE HANDLING. UNDER-INFLATION COULD RESULT IN THE TYRE SLIPPING ON THE RIM.

PERIODIC MAINTENANCE CHART

URAL SERVICE SCHEDULE

Description	Odometer reading, km (miles)							
	New	500 (310)	5000 (3125)	10000 (6250)	15000 (9375)	20000 (12500)	25000 (15625)	30000 (18750)
Check the painted and chromed surfaces for dents, scratches and rust	I			I		I		I
Engine oil*	I	R	R	R	R	R	R	R
Oil filter*		R	R	R	R	R	R	R
Final drive and gearbox oil	I	R	I	R	I	R	I	R
Check valve clearance		I	I	I	I	I	I	I
Check tightness of the cylinder stud nuts		I	I	I	I	I	I	I
Spark plugs		I	I	R	I	R	I	R
Fuel tank filter		I		I		I		I
In-line fuel filter				R		R		R
Ignition timing				I		I		I
Air filter*		I	I	R	I	R	I	R
Check fuel hoses		I	I	I	I	I	I	I
Compliance flanges (check for cracks and other damage)		I	I	R	I	R	I	R
Throttle body synchronization		I	I	I	I	I	I	I
Shock absorbers					I			I
Inspect wheels and tires (tire pressure , tire wear, rims breakage and bents, wheel balancing)*	I	I	I	I	I	I	I	I
Tightness of spokes		I	I	I	I	I	I	I
Tightness of fasteners	I	I	I	I	I	I	I	I
Disc brake (pads, disc, hoses, calipers and cylinders, lever travel)		I	I	I	I	I	I	I
Brake fluid level*		I	I	I	I	I	I	I/R
Check operations of parking brake	I			I		I		I
Front fork oil								R
Clutch, throttle and odometer cables, clutch lever travel	I	I	I	I	I	I	I	I
Bearings of the motorcycle and sidecar swing arms. 2wd linkage on 2wd models, Retro reverse linkage				I		I		I
Steering head bearings				I		I		I
Wheel bearings				I		I		I
Sidecar alignment	I				I			I
Battery (charge level, contacts) *		I	I	I	I	I	I	I
Electrical equipment	I	I	I	I	I	I	I	I
Headlight position	I	I	I	I	I	I	I	I
Lubrication of lever axels, cable ends, rear brakes cams, splined parts of the drive shafts and hubs, drive shaft U-joints*				I/L		I/L		I/L
Test drive	P	P	P	P	P	P	P	P
SERVICE LABOR	.8hrs	2hrs	1.8hrs	3.5hrs	2hrs	3.5hrs	1.8hrs	4.5hrs

I - Inspect, if necessary – adjust, clean or replace
L – Lubricate

R – Replace
P – Perform

* - Also repeat after 1 year in use and after long storage
**- Also inspect when replacing tires

MOTORCYCLE STORAGE AND CARE

Storage

If you will be storing your motorcycle for the winter or long term, take the following steps:

1. The motorcycle should be cleaned.
2. Check all fluid levels and add as necessary.
3. Check tire pressure.
4. Lubricate all shafts, splines, cables and joints.
5. Use a battery maintenance charger or disconnect battery.
6. Always store in a warm dry place to avoid rust and moisture build up.
7. Use a protective cover when needed.

After storage take the following steps prior to running your motorcycle:

1. Perform the pre-ride inspection.
2. Reconnect battery and/or disconnect charger.
3. Follow starting procedures.
4. Take the motorcycle for a short ride prior to any long trips.

CLEANING

It is important to maintain your motorcycle properly and clean on a regular basis. Use the following guidelines when washing your motorcycle:

- Make sure the engine is completely cool
- Use warm soapy water and wash thoroughly
- Avoid water from entering the air filter and electrical components
- After washing dry the motorcycle with a cloth
- Lubricate joints and cables as necessary
- Run motorcycle to evaporate remaining water

WINTER CONSIDERATIONS

Motorists in many areas of the US experience the use of salt and other chemicals that are applied to road surfaces in the winter. Salt and other caustic chemicals should always be washed off your bike with fresh water as soon as possible to avoid rust and corrosion.

NOTE

RUSTED OR CORRODED PARTS CAUSED BY SALT ARE NOT COVERED BY WARRANTY.

2. Motorcycle Controls & Instrumentation

	Page
Hand Controls	2-2
Foot Controls	2-3
Ignition Switch	2-4
Indicator Lamps	2-4
Speedometer Functions	2-5
Speedometer Operation	2-6
Parking Brake	2-7
Reverse Lever	2-7
Kick Starter	2-8
2wd Engagement Lever	2-8
Hydraulic Spring Shock Absorbers	2-9
Hydraulic Steering Damper	2-9

HAND CONTROLS

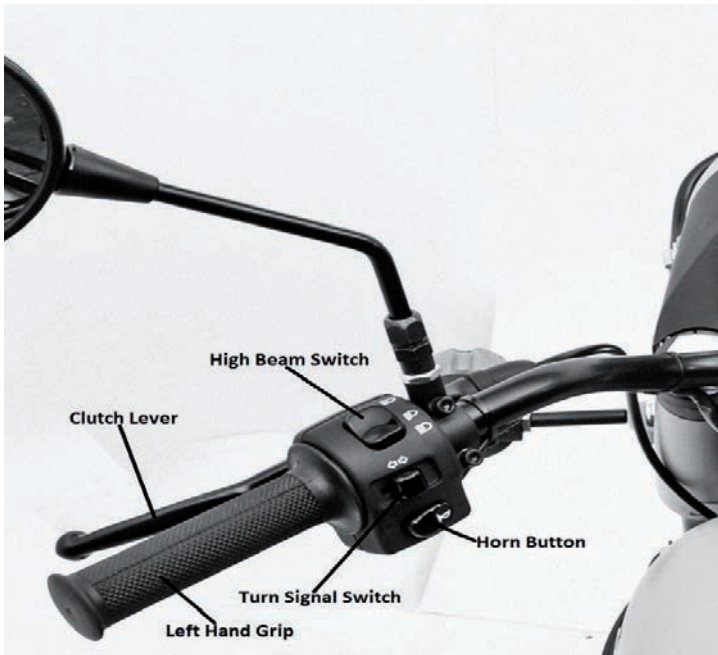

Clutch Lever

Pulling the clutch lever will disengage the clutch while releasing the lever will engage the clutch.

High Beam Switch

Toggle the switch forward to turn on the high beam and toggle back for “Flash to Pass” feature.

Horn Button

Press the button to sound the horn.

Turn Signal Switch

Switch left or right to indicate turns and push the button to cancel.

Left Hand Grip

Place your left hand on the grip to steer and control the motorcycle.

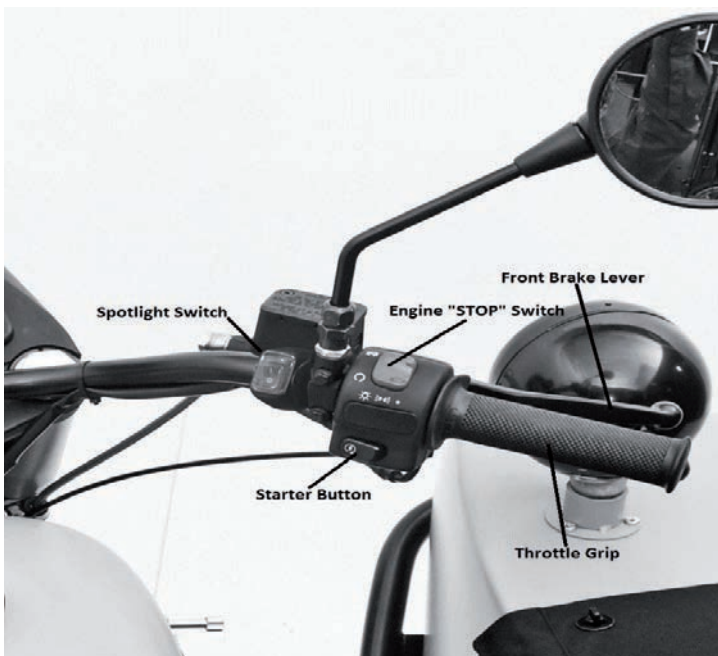

Front Brake Lever

Pulling the lever will actuate the front brakes.

WARNING

IF THE BRAKE LEVER FEELS SPONGY DO NOT RIDE THE BIKE AND CONTACT YOUR DEALER.

Starter Button

Press the button to engage the starter motor.

WARNING

WHEN USING THE STARTER ALWAYS BE SURE THE GEARBOX IS IN NEUTRAL.

Engine “STOP” Switch

Toggle the switch forward to stop the engine, toggle back to run.

Throttle Grip

Place your right hand on the grip to steer and control the motorcycle. Rotate the grip back to open the throttle.

Spotlight Switch (If equipped)

Toggle the switch to control the sidecar spotlight.

FOOT CONTROLS



Heel-Toe Shift Lever

Shift Lever

This is a heel-toe type shifter, to upshift use the heel portion of the shift lever, to down shift use the toe portion of the shifter.



Rear Brake Lever

Rear Brake Lever

Pressing the rear brake lever actuates the rear and sidecar brakes.

WARNING

IF THE BRAKE LEVER FEELS SPONGY DO NOT RIDE THE BIKE AND CONTACT YOUR DEALER.
--

IGNITION SWITCH

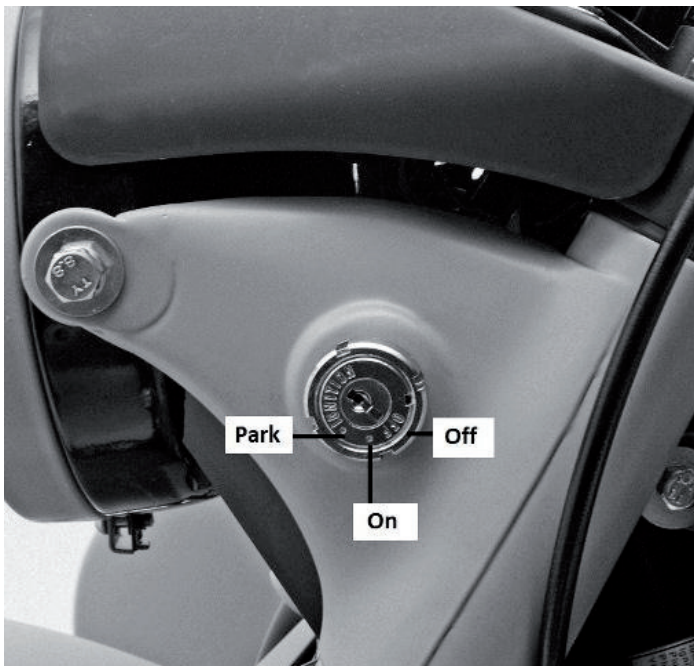

(3 Position Switch)

In the “Off” position the engine cannot be started.

In the “On” position the engine can be started and all electrical functions can be used.

In the “Park” position only the running lamps (not including headlight) are illuminated.

INDICATOR LAMPS



1. Engine “MIL” Indicator

If lamp illuminates while engine is running refer to “Troubleshooting” section of this manual.

2. High Beam Indicator

Lamp will illuminate when high beam is on.

3. Charging System Failure Indicator

Lamp will illuminate if the alternator fails

4. Parking Brake Indicator

Lamp will illuminate when the parking brake is engaged.

5. Gearbox Neutral Indicator

Lamp will illuminate when gearbox is in neutral.

6. Turn Signal Indicator

Lamp flashes when signals are active.

7. Low Fuel Level Indicator

While on Level ground lamp will flash when fuel level is low and become solid when on reserve level (app. 1 Gal.)

NOTE

FUEL LAMP CAN GIVE FALSE INDICATION DUE TO SLOSHING WHILE RIDING. CHECK LAMP ON LEVEL GROUND.

SPEEDOMETER FUNCTIONS



Needle Speedometer:

Indicates speed by analogue needle.

RPM: Digital Tachometer

NOT ACTIVE

MAX RPM: Maximum Tachometer

NOT ACTIVE

SPD: Speedometer

Displays speed in MPH.

MAX SPD: Maximum Speed Meter

Displays highest speed achieved since last Reset operation.

AVG: Average Speed Meter

It calculates average speed from last RESET.

TRIP 1 or 2: Trip Meter 1 or 2

TRIP function accumulates trip distance since last RESET as long as bike/vehicle is moving.

ODO: Odometer

ODO accumulates total distance traveled.

RT: Riding Timer

1. Calculates total running time since last RESET.

2. Counter automatically begins with movement.

TT: Total Riding Timer

1. Calculates total riding time from the beginning of the bike.

2. TT data is stored in memory, and cannot be reset.

HRTT: Total Hour Meter

1. Calculates total engine operation time.

12/24 hour Clock:

It displays 12 or 24 hour current time.

Digital Voltage:

Indicates range 8-18VDC.

+TRIP: Maintenance Reminder

1. The maintenance reminder is set by trip meter and an "Off" mode to switch it off.

2. The trip meter maintenance can be set up to 9999.

SPEEDOMETER OPERATION



MODE Button

Press the MODE button to move from one function screen to another.

RESET Button

Press the reset button to cycle through functions in reverse order.

Data Resetting

1. Press MODE or RESET button to reach the desired screen then press RESET button for 2 seconds to reset TRIP 2, MAX SPD, MAX RPM and MAX TEMP data from stored values to zero individually. The maintenance reminder will be reset to the pre-set value.
2. The data of Trip 1, AVG & RT will all be reset at the same time when one of the 3 data functions are being reset.
3. ODO, clock, HRTT and TT data cannot be reset.

Data Programing

Press both MODE & RESET buttons to go into setting mode. In setting mode, pressing the RESET button increments the flashing digit by 1 position. Press MODE button to confirm the digit setting and jump to next digit or next setting screen to be set. Press MODE button for 2 seconds on any setting screen to finish and go to normal mode.

12/24 Hour Clock Set-up

Clock displays 12 or 24H in XX:XX:XX format and AM/PM when you select 12H option. Use MODE and RESET buttons as described above in **Data Programing** to finish clock setting and jump to the maintenance reminder setting or press MODE button for 2 seconds to finish and go to normal mode.

Maintenance Reminder Set-up

The maintenance reminder displays a picture of a wrench and is a separate TRIP meter. You can program the maintenance trip meter for the next scheduled service interval. Use MODE and RESET buttons as described above in **Data Programing** to finish maintenance reminder setting. Press MODE button for 2 seconds to finish and go to normal mode.

PARKING BRAKE



Parking Brake Lever

The parking brake lever is located on the left handle bar.

Pulling the handle to the left lock position sets the parking brake.

Release the parking brake by pushing the lever to the right position as shown.

CAUTION

OPERATING THE MOTORCYCLE WHILE THE PARKING BRAKE IS ENGAGED CAN DAMAGE THE BRAKE SYSTEM.

REVERSE LEVER

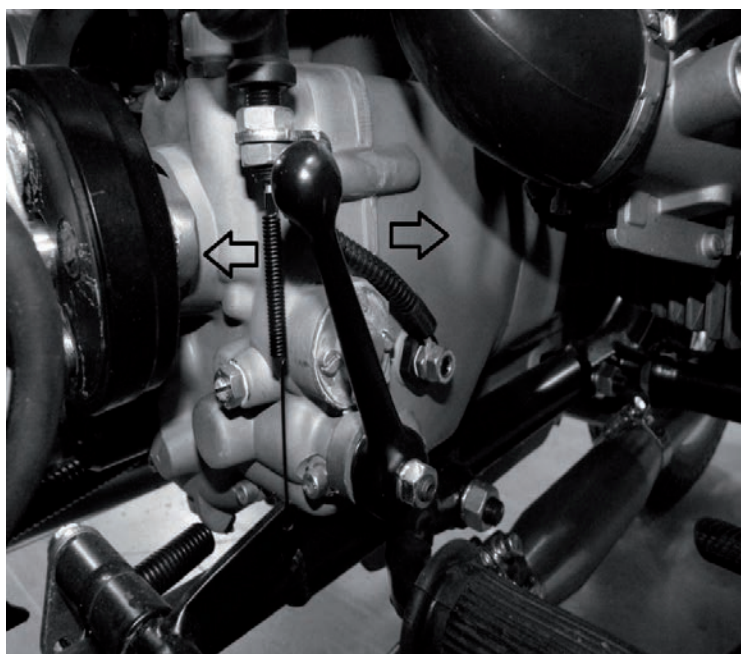

Reverse Engagement Lever

The reverse lever is located on the right side of the gearbox near the foot peg.

Pulling the lever back while in Neutral will engage the reverse gear.

Push the lever forward to put the gearbox back into Neutral and use forward gears.

CAUTION

THE REVERSE LEVER MUST BE IN THE FULL FORWARD POSITION FOR THE GEARBOX TO SHIFT PROPERLY.

KICK START LEVER



Kick Start Lever

To use the kick start lever rapidly press the lever downward with your right foot as shown.

WARNING

WHEN USING THE KICK STARTER ALWAYS BE SURE THE GEARBOX IS IN NEUTRAL.

2WD ENGAGEMENT LEVER (Not available Australian models)

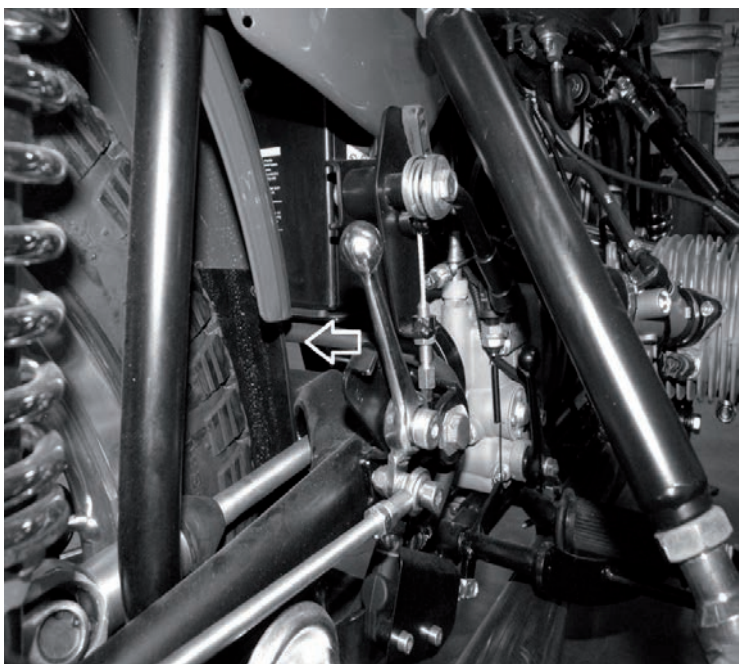

2wd Engagement Lever

Shifting the lever into the rear locked position will engage 2wd.

Move the lever to the forward position to dis-engage 2wd.

CAUTION

2WD SHOULD ONLY BE USED FOR LOOSE ROAD CONDITIONS AND/OR OFF ROAD PURPOSES.

WARNING

USE OF 2WD ON THE STREET CAN MAKE THE MOTORCYCLE DIFFICULT TO STEER POSSIBLY RESULTING IN LOSS OF CONTROL.

HYDRAULIC SPRING SHOCK ABSORBERS



Adjustable Shock Absorbers

The shock absorbers have 5 preload adjustments.

Rotate the adjustment ring counter clockwise as shown to increase spring preload using the supplied wrench in your tool kit.

HYDRAULIC STEERING DAMPER



Adjustable Damper (16 Position)

The steering damper is fully adjustable to accommodate different riding styles and conditions.

Rotate the adjustment rod clockwise to increase dampening and counter clockwise to reduce dampening.

CAUTION

OVER ROTATION OF THE ADJUSTMENT ROD CAN DAMAGE THE DAMPER AND/OR CAUSE FLUID LEAKS.

3. Motorcycle Operation

	Page
Pre-ride Inspections	3-2
Initial Ride Instructions	3-2
Sidecar Safety	3-3
Starting Procedures	3-5
Run-In	3-6
Motorcycle Use and Loading	3-6

PRE-RIDE INSPECTIONS

Prior to each ride you should inspect the motorcycles technical condition for safety. Use the following pre-ride inspection list to ensure your motorcycle is safe and ready to ride.

1. Check the oil level. Low oil level causes premature wear and possible engine damage.
2. Check the fuel level.
3. Check the tire pressure. Low tire pressure can cause poor handling, also inspect the tire for abnormal and/or excessive wear that may lead to a flat tire.
4. Check all lights for proper operations including headlight, running lights, turn signals, and brake lights.
5. Check the brakes for proper operations and correct fluid level. If for any reason the brakes feel abnormal or spongy do not ride the bike as it may be unsafe.
6. Inspect all cables to insure they are not pinched or routed improperly; also inspect the clutch cable for correct free play.
7. Check for any loose fasteners and tighten as necessary.
8. Be sure any luggage is secured before riding.

INSTRUCTIONS FOR INITIAL RIDE

The following steps should be taken prior and during your first ride:

1. Read the entire owner's manual prior to starting and/or taking you first ride.
2. Familiarise yourself with all controls and instruments.
3. Make any required adjustments to mirrors and controls for comfort.
4. Always wear safety gear including but not limited to: helmet, boots, gloves, and jacket regardless of weather.
5. Ride in a safe environment such as a parking lot or area you are familiar with while you learn the specific handling characteristics of your new sidecar motorcycle.
6. Follow the "Engine Run-in" instructions.

SIDECAR SAFETY

The Ural sidecar motorcycle, since it has three wheels, behaves quite differently from either a solo motorcycle or a car. For these reasons the following label has been attached to your motorcycle tank:

WARNING: LEFT-HAND AND RIGHT-HAND TURNS MAY BE DANGEROUS. EXCESSIVE SPEED AND AN UNWEIGHTED SIDECAR MUST BE AVOIDED.

Like any other motor vehicle, if the Ural is driven beyond its design limits, you can get hurt. Properly driven, since you have the added stability of the third wheel in case of sand, ice or slippery road conditions, the Ural will give you a much safer ride than a solo motorcycle in adverse conditions.

If possible, an experienced sidecar driver (preferably your Authorised Ural dealer) should ride along during your first ride. If not, put about 50kg of ballast in the sidecar during your initial training. Although an experienced driver can safely drive the Ural with an empty sidecar a beginner should always have ballast or a passenger in the chair.

Check with your local Ural Dealer to find out your particular state's sidecar driver's license requirements.

When you accelerate, the Ural will pull slightly to the right due to the inertia and drag of the side car.

When you let off the gas it will pull slightly to the left due to the inertia of the sidecar.

Practice starting and stopping from various speeds, shifting up and down, accelerating and decelerating in each gear, turning right and left at slow-to-medium speeds.

WARNING

The Patrol and Gear-up with engageable sidecar wheel handles differently with the sidecar driveshaft engaged and cannot turn on paved roads. For this reason, the sidecar drive must only be engaged when operating the vehicle off-road or where snow, ice and mud conditions are encountered on road.

SIDECAR SAFETY (CONT.)

Finally, practice lifting the sidecar. To do this drive in an anti-clockwise circle about 6 metres in diameter. Gradually increase your speed until the sidecar wheel lifts from the surface 120mm – 300mm. Then roll off the throttle and ease steering pressure on the grips so it gradually comes back down. Repeat doing this until you feel comfortable with the wheel in the air. Remember, the moment you roll off the throttle it will come down. When you have mastered “flying the chair” to the point where you can keep it in the air for a full circle you will have a good feel for the speed and turn radius that will lift the sidecar.

If, after gaining proficiency with the Ural, you plan to drive on the street with an empty sidecar, go back to the parking lot and practice the above maneuvers with an empty sidecar. You’ll find that the sidecar will lift much more readily when it is empty, especially if you enter a decreasing radius turn (such as a freeway off ramp) at too high a speed. This is why we recommend generally carrying about 50kg or more in the sidecar.

WARNING

BALLAST WEIGHT SHOULD ALWAYS BE PROPERLY SECURED IN THE SIDECAR AND CENTERED FOR BEST BALANCE.

STARTING THE ENGINE WHEN COLD

Use the following instructions when starting a cold engine:

1. Check to be sure you have enough fuel.
2. Switch ignition on.
3. Be sure the transmission is in neutral.
4. Switch the kill switch to run.
5. Press the starter button or use the kick starter until engine starts.
6. Allow engine to warm for a few moments prior to riding.

NOTE

ENGINE CRANKING SPEED CAN BE REDUCED IN COLD WEATHER, FOLLOW THE RECOMMENDATIONS FOR PROPER OIL WEIGHT FOUND ON PAGE 4-2.

CAUTION

DO NOT ACCELERATE WHILE STARTING THE BIKE! DO NOT RUN STARTER FOR MORE THAN 5 SECONDS. NEVER STAND IN FRONT OF THE MOTORCYCLE WHILE THE ENGINE IS RUNNING.

STARTING THE ENGINE WHEN WARM OR HOT

Use the following instructions when starting a warm or hot engine:

1. Check to be sure you have enough fuel.
2. Switch ignition on.
3. Be sure the transmission is in neutral.
4. Switch the kill switch to run.
5. Press the starter button or use the kick starter until engine starts.

CAUTION

DO NOT ACCELERATE WHILE STARTING THE BIKE! DO NOT RUN STARTER FOR MORE THAN 5 SECONDS. NEVER STAND IN FRONT OF THE MOTORCYCLE WHILE THE ENGINE IS RUNNING.

ENGINE RUN-IN

During the first 1000 kilometres it is important not to overload or over rev the engine while riding. To ensure proper break-in you should ride the motorcycle conservatively at varying speeds and loads. Use the following guidelines during the first 1000 kilometres prior to the initial break-in service:

1. Do not overload or “lug” the engine.
2. Do not exceed a top speed beyond 60mph.
3. Do not ride at a constant rpm for long periods of time.
4. Try to vary speed and load when riding.
5. Shift smoothly between gears and do not down shift at high rpm.
6. Always be sure the engine is warmed up before riding.
7. Follow the pre-ride inspection.

MOTORCYCLE USE AND LOADING

Here are few things to consider for the best experience while planning and preparing your sidecar outfit for a trip. Remember, sidecars and their handling characteristics differ from their two wheeled counterparts.

Air cooled - Heat is detrimental to air cooled engines. When planning for a ride, consider a few factors before choosing your route.

- **What is the ambient temperate?**
- **Will I have a passenger or additional payload?**
- **What is the best route for the speed I will be able to maintain?**

External Temperature – Keep in mind how maintaining high rates of speed or carrying additional cargo can affect the temperature of the motor, planning ahead while riding in warmer temperatures or with added payload will lessen the likelihood that you will encounter an unexpected change of plans.

High Speed – Urals are geared and tuned for off road use while providing the capability of long distance travel. The ability to do both restricts maximum speed. Maintaining max speeds all day can be taxing on the drivetrain, plan ahead to arrive on time to your destination.

- **Rider, no passenger or payload: 100-110 kph.**
- **Rider and passenger, no payload: 95-100 kph.**
- **Rider, Passenger and payload up to max GVW 80-95 kph.**

Ural recommends a maximum speed of 110 kph. - The recommended max speed is not intended to be maintained for long periods of time. Reduce maintained max speed accordingly as temperatures rise throughout the day and/or if you will be traveling long distances with additional payload.

- **Reduce max speed for heavy payloads and as ambient temperatures rise.**
- **Allow the motor to cool at fill-ups, take a break before resuming on a long trip.**
- **Give your Ural 20 minutes to cool for every 2 hours.**

Long Distance - Ural motorcycles are very capable of long distances if routine maintenance, rate of speed and the load are adjusted accordingly based on the conditions.

- **If traveling in warm temperatures, reduce speed and/or make periodic cooldown stops.**
- **Make it a habit on longer trips to check oil at fill-ups and cooldown/rest stops. High temperatures and sustained speed can lead to higher level of oil consumption.**

Off Road - Off road riding includes but is not limited to fire roads, desert trails, snow covered, obstructed, rutted, pot holed, rock covered paths, quarries, beaches, mud holes, etc. or any environment where speed, weight, traction, temperature extremes and other elements effect operation and/or navigation and the demands of the motorcycle beyond that of normal on highway use.

- **Do not ride beyond your skill level or the abilities of the motorcycle.**
- **Do not embark on unknown routes without proper resources to assist you in the event that an unforeseen circumstance does arise.**

If you choose to use your sidecar outfit in the manner outlined above, expect that maintenance and/or repairs **will be** required in addition to the regular service intervals.

Items often requiring inspection, service and/or repair after aggressive off road riding include but is not limited to:

- **Nuts, bolts, screws and other retaining fasteners that may have loosened or lost due to vibration.**
- **Tyres, tubes, spokes, wheel rims, shocks, steering damper, steering head bearings and swing arm pivot points.**
- **Clutch wear, cable stretch, brake pad wear, electrical connections and lighting.**

Load - The max permissible weight should be considered when planning a trip, choosing a route and while loading the outfit. Use common sense, particularly if you're planning to go off road.

- **Shock preload should be appropriate for the terrain and payload.**
- **Tyre pressure should be in accordance with the specifications in the owner's manual.**
- **Clutch cable free play should be to specification to avoid excessive clutch slippage while navigating rough roads, loose sand or gravel, mud, etc.**
- **Being overloaded on the road and particularly over continuous rough terrain will deteriorate the sidecar bodies' rubber suspension faster than normal.**
- **When loaded and off road, navigate obstacles slowly and cautiously, reduce speed over rough terrain.**

Recommend Max Additional Payloads

Ranger

270kg Max Additional Payload

M70/Retro

195kg Max Additional Payload

cT

200kg Max Additional Payload

Wind Drag & Load Equalization – Two elements often overlooked are wind drag and balancing the payload.

Maximum cruising speeds should be reduced from the recommended maximum for sidecar outfits with windscreens that increase wind drag. This can create excessive heat leading to premature fatigue of vital components and possibly increase oil consumption.

Avoid “piling on” cargo in any location of the outfit that will act as a sail, increase wind drag and increase strain on the drive train. Unbalance loads will change the handling characteristics in turns, while cornering and while braking. Optimise loading of cargo for better handling and safer operation.

Sidecar Loading Balance Percentage

Trunk area = 20%, Passenger Area = 70%, Front of Sidecar = 10%

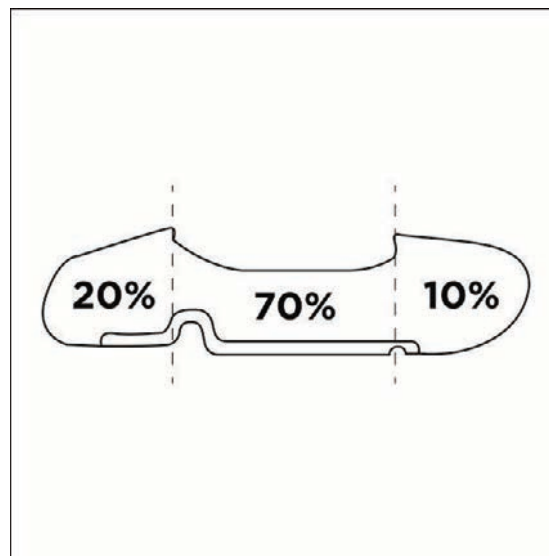

Accessory Location Do's and Don'ts – In addition to payload effects on handling and heat generating strain on the drivetrain, consider where accessories are to be mounted to maximise handling and safety.

- **Do mount factory authorised accessories with common sense in logical locations that avoid weakening substrates or anywhere that would jeopardise chassis integrity.**
- **Don't mount accessories in areas that will effect driver control, inhibit or limit steering function, pull throttle cables, limit brake pedal accessibility, etc.**
- **Don't mount Jerry cans or other hazardous items to the front area of the sidecar or anywhere an impact is more likely to create a safety hazard.**

Know Your Motorcycle – Be a contentious rider and use your senses to alert you to potential changes in the performance of the drivetrain; sight, sound, smell, and feel.

- **Look at your dipstick, has oil consumption increased? The engine can use 16-26 millilitres of oil every 160 kilometres depending on riding conditions.**
- **Do you hear anything out of the ordinary? Are the brakes squeaking? A good running Ural has been compared to a sewing machine. If the pitch of the engine has changed or valve train is making excessive noise, this could be a sign to take a break and let the engine cool. If the sound continues, further diagnosis will be required.**
- **Do you smell burnt oil, smoking clutch, rubber, fuel? Any smell that stands out while riding or while stopped should be investigated to determine the source and assess the situation.**
- **Have you felt a loss of power, a shudder while stopping or maybe the brake lever feels different? Any changes that cannot be attributed to road conditions, wind, etc. should be investigated as soon as is safe to do so.**

Know your warranty - Know the limits of your warranty coverage as outlined in the owner's manual.

- **Purchase a road side assistance program in addition to or separate from your insurance to cover unexpected towing expenses should they arise.**
- **Are Ural dealers or service centres available along the chosen route? If no Ural shops, are there repair facilities that can handle tyre changes, oil changes, etc.**

For longer trips, carry Ural specific spares for wear items not covered by warranty like, oil filters, brake pads, u-joints, etc.

4. Lubrication

	Page
Recommended Fluids, Lubricants & Capacities	4-2
Lubrication Diagram	4-3
Lubrication Points	4-4
Engine oil and filter replacement	4-5
Gearbox oil replacement	4-7
Final drive oil replacement	4-8
Drive Shaft Lubrication	4-9
Cable Lubrication	4-10

FLUIDS, LUBRICANTS & CAPACITIES

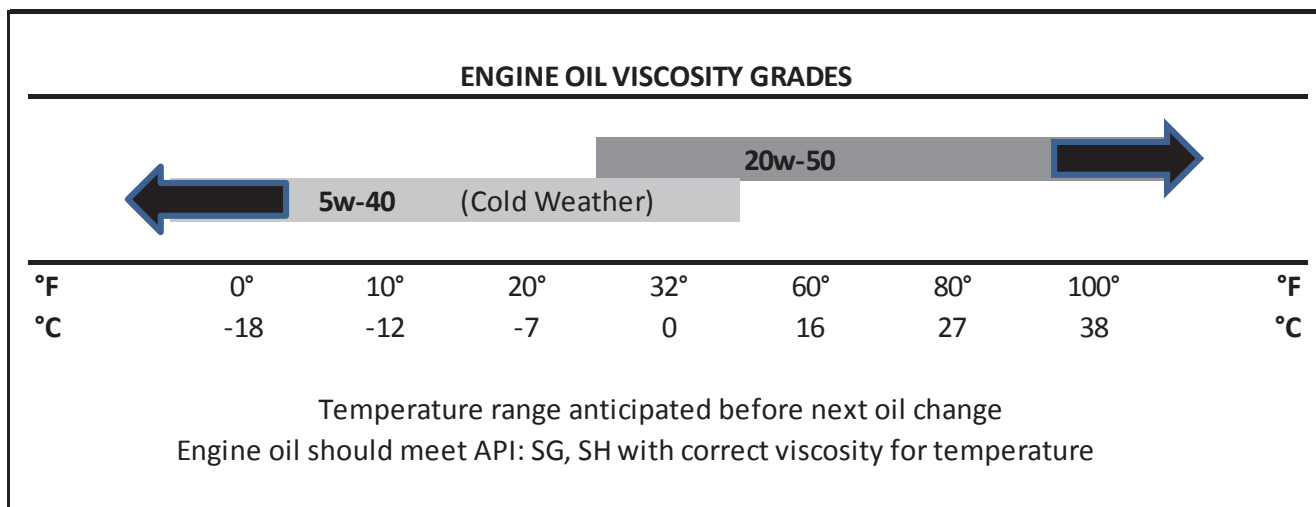

Location	Capacity	Type
Engine (with Filter Change)	2.1 l	20w-50 API: SG, SH
Gearbox	0.9 l	20w-50 API: SG, SH
Final Drive 2wd	135ml	80W-90 GL-5 Gear Oil
Final Drive 1wd	110ml	80W-90 GL-5 Gear Oil
Front Brake Reservoir	20 cm ³	DOT 3 or DOT 4
Rear Brake Reservoir	15 cm ³	DOT 3 or DOT 4
Sidecar Brake Reservoir	30 cm ³	DOT 3 or DOT 4
Drive Shaft Joints	N/A	General Purpose Lithium Grease
Drive Shaft Spines	N/A	Moly EP Grease
Clutch Shaft Splines	N/A	Moly EP Grease
Drive Wheel Splines (Spline Flanges)	N/A	Moly EP Grease
Wheel Axles	N/A	General Purpose Lithium Grease
Brake Linkage and Pivots	N/A	General Purpose Lithium Grease
Cables	N/A	WD-40

LUBRICATION DIAGRAM

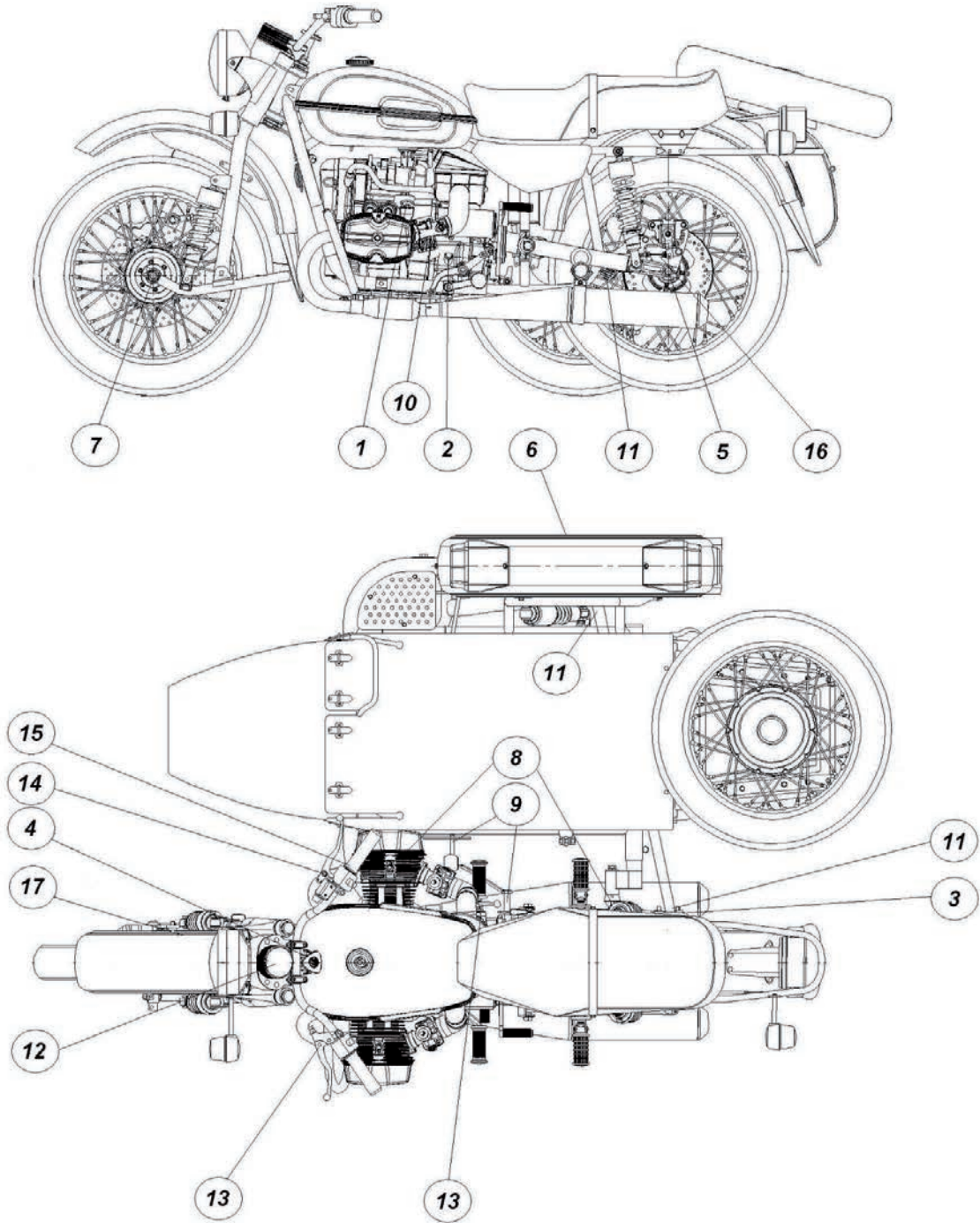

LUBRICATION POINTS

Diagram Position	Location	Type
1	Engine Oil Fill	20w-50 API: SG, SH
2	Gearbox Oil Fill	20w-50 API: SG, SH
3	Final Drive Oil Fill	80W-90 GL-5 Gear Oil
4	Steering Head Bearing	General Purpose Lithium Grease
5	Final Drive Output Spines	Moly EP Grease
6	Sidecar Drive Shaft Splines (2wd)	Moly EP Grease
7	Axles	General Purpose Lithium Grease
8	Sidecar Mounting Pivots	General Purpose Lithium Grease
9	Sidecar Brake Linkage Bushing	General Purpose Lithium Grease
10	Clutch Shaft Splines	Moly EP Grease
11	U-Joints	General Purpose Lithium Grease
12	Speedometer Cable	WD-40
13	Clutch Cable	WD-40
14	Front Brake Lever Pivot Bolt	WD-40
15	Throttle Cables	WD-40
16	Parking Brake Cables	WD-40
17	Front Brake Mount Axle Bushings	General Purpose Lithium Grease

ENGINE OIL & FILTER REPLACEMENT



Step 1

Place a drain pan under the oil sump and remove the drain plug using a 17mm socket wrench.



Step 2

With the drain pan in place remove the oil filter.

NOTE

AN OIL FILTER WRENCH MAY BE REQUIRED FOR REMOVAL

CAUTION

BE SURE TO REMOVE THE OIL FILTER SEALING RING FROM THE ENGINE COVER TO AVOID OIL LEAKS

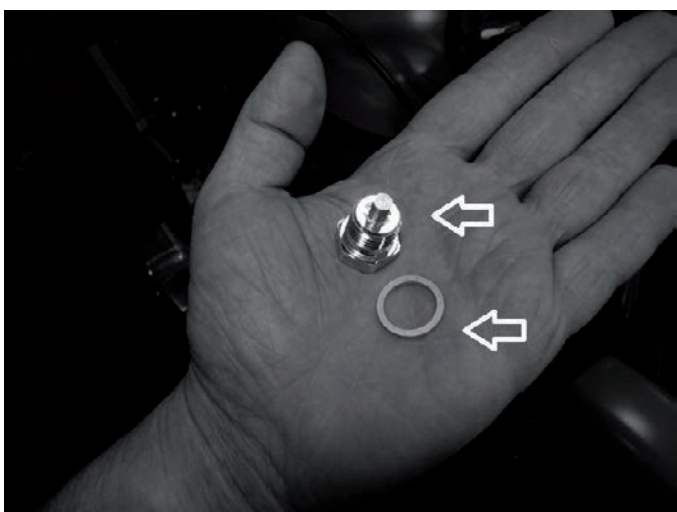

Step 3

Be sure to clean any metal contaminants from the drain plug and replace the drain plug sealing washer.

Step 4

Re-install drain plug and washer and torque to specification.

ENGINE OIL & FILTER REPLACEMENT (CONT.)



Step 5

Lightly lubricate the new oil filter sealing ring with fresh oil and install filter tightening approximately $\frac{1}{4}$ turn after seat of seal.

CAUTION

DO NOT OVER-TIGHTEN THE OIL FILTER



Step 6

Fill engine with 2.1L of recommended motor oil

Step 7

Start the engine and let run for 30 seconds, confirming you have no oil leaks at filter.

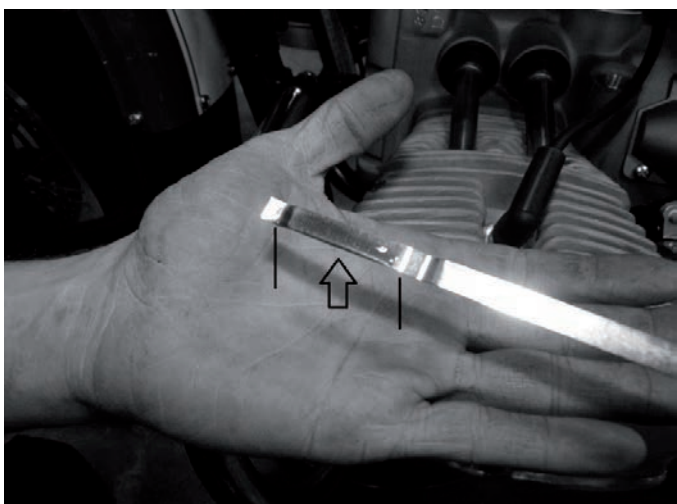

Step 8

Check oil level, oil should be full to the upper mark on the dipstick, add oil as needed.

NOTE

ALWAYS DISPOSE OF MOTOR OIL PROPERLY

GEARBOX OIL REPLACEMENT



Step 1

Place a drain pan under the gearbox and remove drain plug using a 17mm socket wrench.

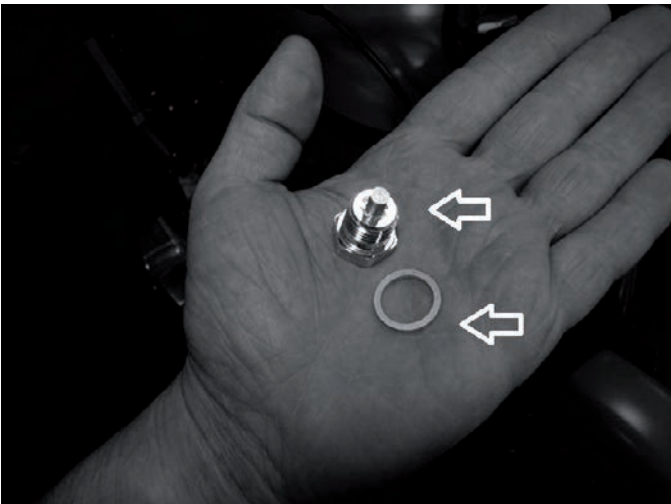

Step 2

Be sure to clean any metal contaminants from the drain plug and replace the drain plug sealing washer.

Step 3

Re-install drain plug and washer and torque to specification.

Step 4

Fill the gearbox with .9L of recommended motor oil.

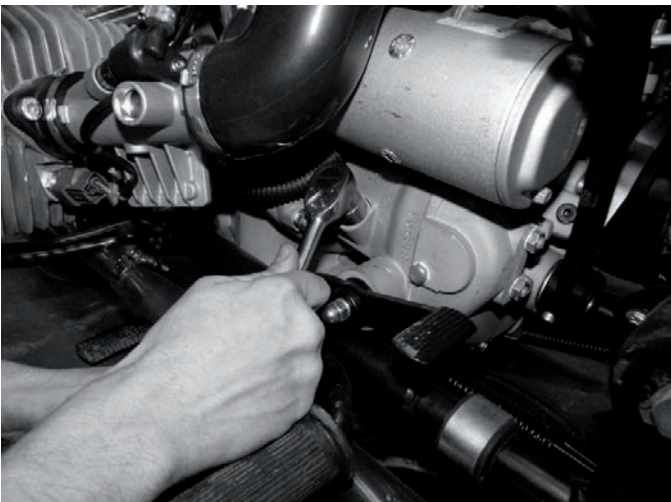

Step 5

Re-install fill plug and torque to specification.

NOTE

ALWAYS DISPOSE OF MOTOR OIL PROPERLY

FINAL DRIVE OIL REPLACEMENT

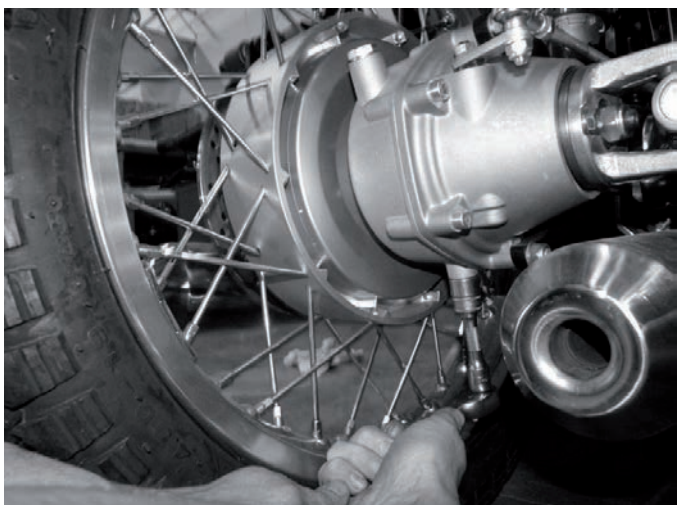

Step 1

Place a drain pan under the final drive and remove the drain plug using a 17mm socket wrench.

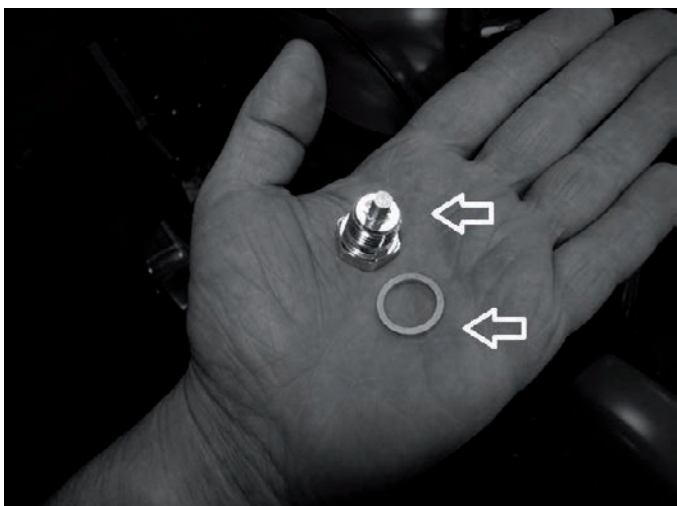

Step 2

Be sure to clean any metal contaminants from the drain plug and replace the drain plug sealing washer.

Step 3

Re-install drain plug and washer and torque to specification.

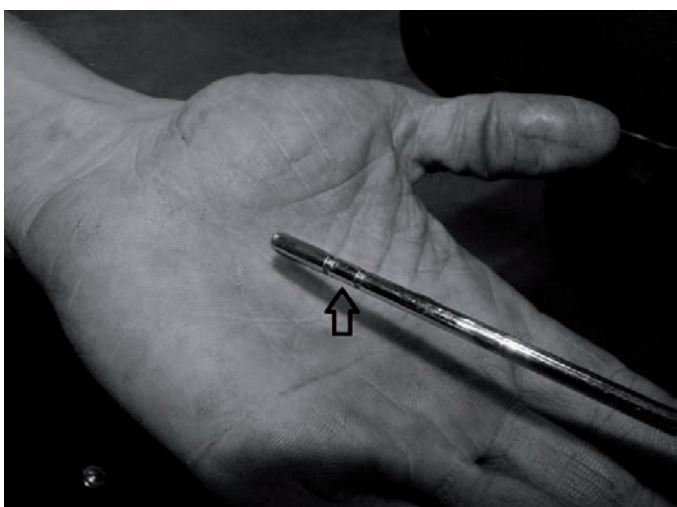

Step 4

Fill the final drive with 135ml (2wd) or 105ml (1wd) of recommended gear oil.

Step 6

Check oil level by threading the dipstick into the case, oil should be full to the upper mark, add fluid as needed.

NOTE

ALWAYS DISPOSE OF GEAR OIL PROPERLY

DRIVE SHAFT & SPLINE LUBRICATION



Final Drive Shaft

U-Joints should be lubricated with grease using a grease gun.

The rear drive shaft has one grease zerk located at the u-joint; grease this joint per the maintenance intervals or after off road use.

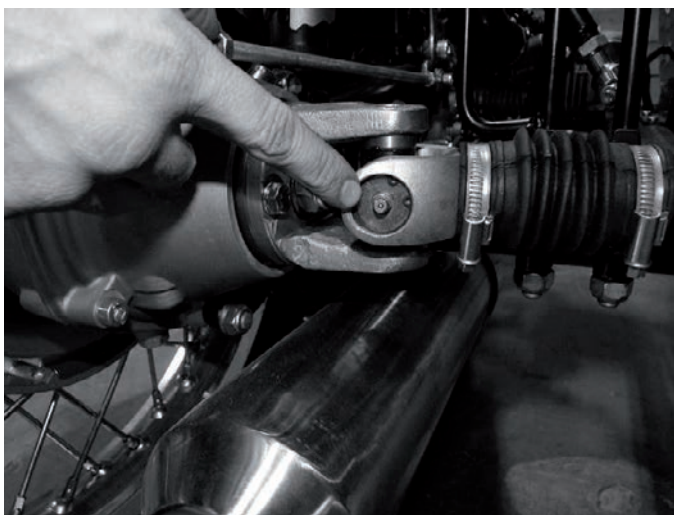

Sidecar Drive Shaft

On 2wd models only the sidecar drive shaft has two grease zerks located at each u-joint; grease these joints per the maintenance intervals or after off road use.

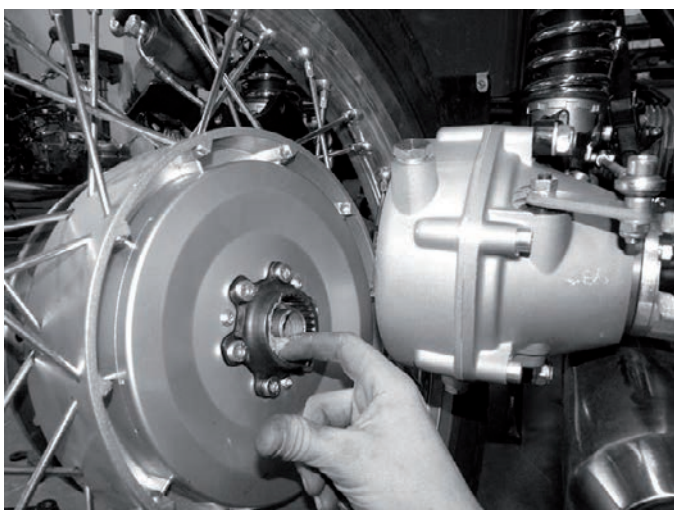

Drive Wheel Splines

The rear wheel drive splines should be greased per the maintenance intervals or after off road use.

2wd models also have drive splines located on the sidecar wheel; splines should be greased per the maintenance intervals or after off road use.

CABLE LUBRICATION



All cables including the clutch, speedometer, throttle, and parking brake cables should be lubricated with cable lube or WD-40 per the maintenance intervals. You should also lubricate all cables before and after extended periods of storage and/or after off road use.

To lubricate the cables pull back the protective covers and apply lube directly to the cable as shown, you can also use cable lubrication tools available by aftermarket companies.

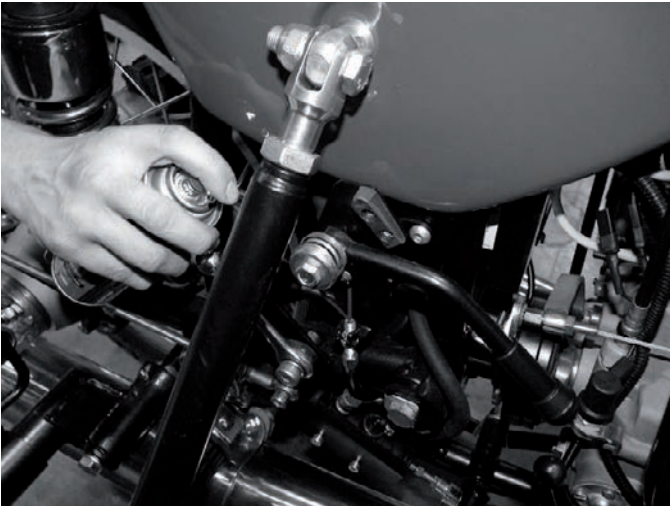

5. Engine & Chassis Maintenance

	Page
Air filter Inspection & Replacement	5-2
Fuel System Maintenance	5-3
Valve Train Inspection & Adjustment	5-5
Front Brake System Maintenance	5-7
Rear Brake System Maintenance	5-9
Parking Brake Adjustment	5-11
Sidecar Brake System Maintenance	5-12
Wheel Removal & Installation	5-14
Using the Spare Wheel	5-22
Spoke Maintenance	5-22
Wheel Bearing Replacement & Diagrams	5-23
Tire & Tube Replacement	5-24
Sidecar Alignment	5-25
Sidecar Alignment Diagram	5-26

AIR FILTER INSPECTION & REPLACEMENT

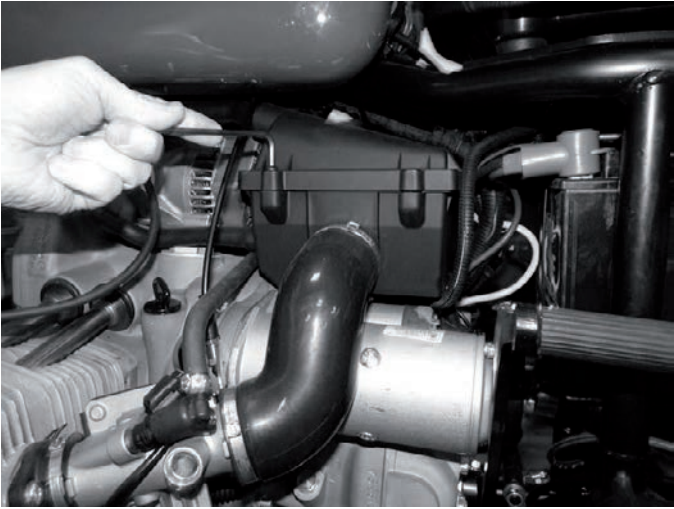

Step 1

Remove the four retaining bolts from the air box lid using a 5mm hex wrench.

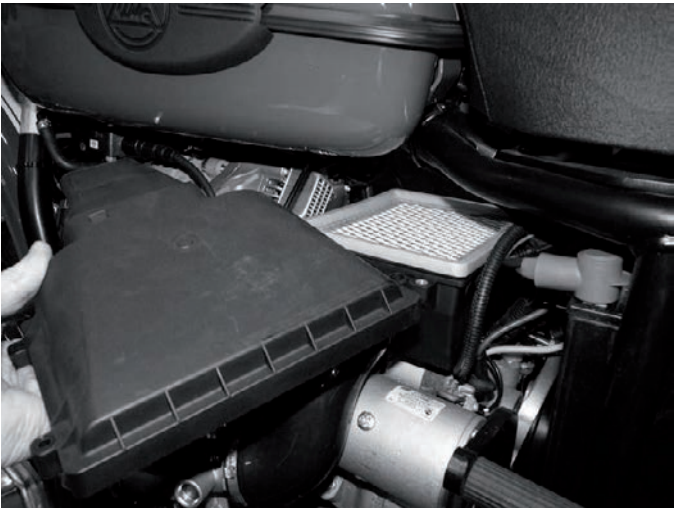

Step 2

Carefully remove the air box lid by lifting the right side and sliding the lid to the left, be very careful not to pull wiring and cables near the air box inlet.

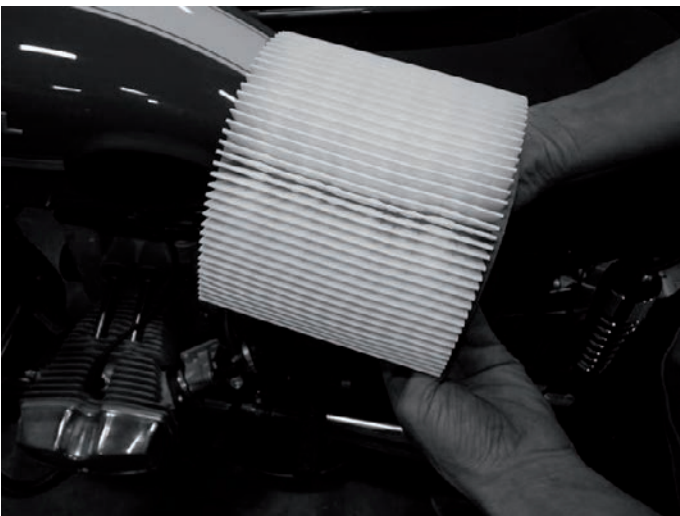

Step 3

Remove the paper filter element from the housing and inspect for debris. The filter should be replaced per the maintenance intervals and/or as need during inspections.

Step 4

Re-install the filter in reverse order, be sure the replacement filter is fully seated in to the air box housing and the lid is properly installed prior to tightening the retaining bolts.

CAUTION

A DIRTY OR CLOGGED AIR FILTER CAN REDUCE THE PERFORMANCE OF YOUR ENGINE AND POSSIBLY DAMAGE INTERNAL ENGINE PARTS.

FUEL SYSTEM MAINTENANCE



Step 1

Place a rag under the fuel pump return line located on the left side of the pump and remove the fitting by pinching the release tabs.

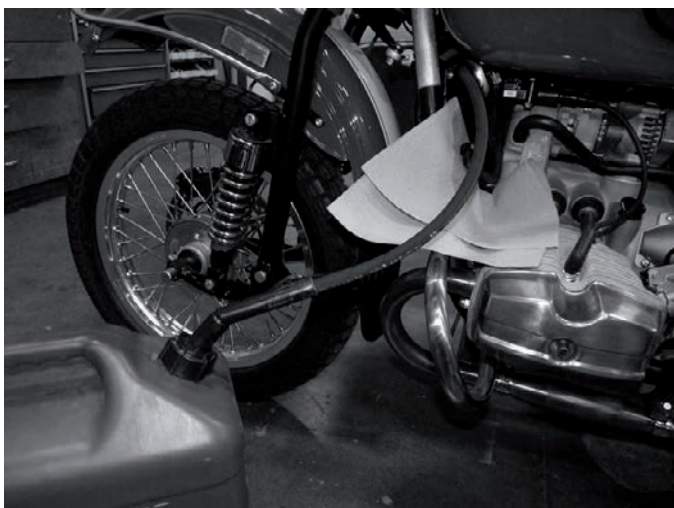

Step 2

Connect a fuel hose to the pump outlet to drain the fuel into a fuel canister.

Step 3

Turn the ignition key on and switch the run switch to the on position so the pump can cycle all fuel from the tank into the canister. This can take a few moments. Be sure not to run the pump dry after all fuel has been drained from the tank.

Step 4

Re-install the return fuel line to the pump.

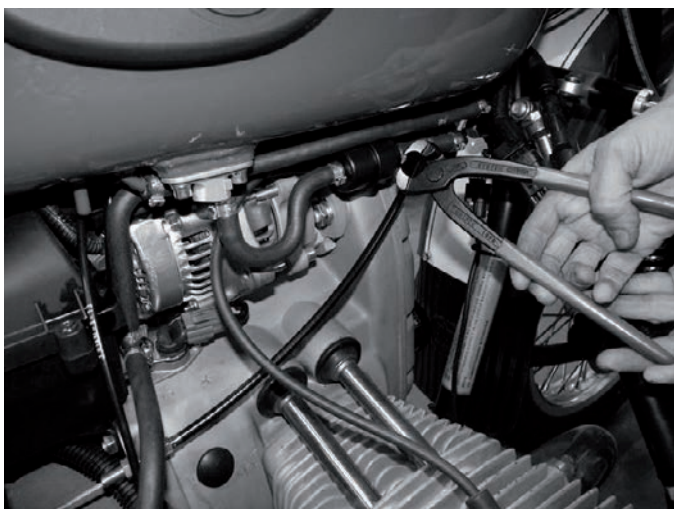

Step 5

Carefully remove the one-time-use clamps from both sides of the in-line fuel filter.

WARNING

THE FUEL SYSTEM IS UNDER PRESSURE.

WARNING

GASOLINE IS EXTREMELY FLAMABLE.

FUEL SYSTEM MAINTENANCE (CONT.)



Step 6

Remove the in-tank screen filter.



Step 7

Clean all debris for the intake filter and re-install in the tank.

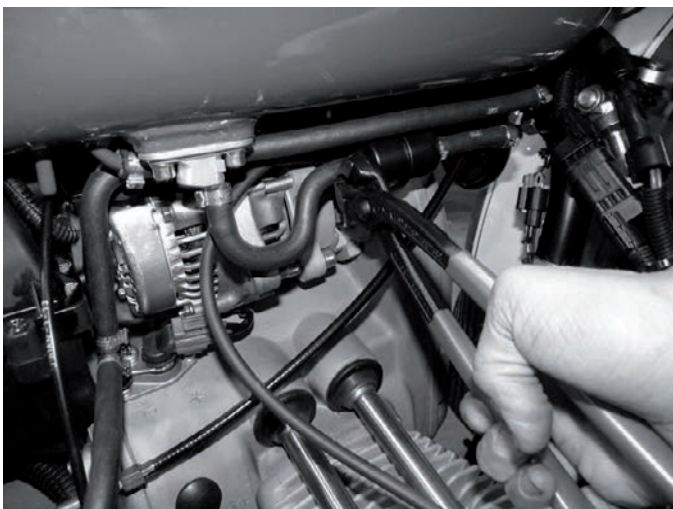

Step 8

Install the new in-line fuel filter and replace all one-time use clamps.

NOTE

INSTALL IN-LINE FILTER WITH DIRECTIONAL ARROW POINTED FORWARD.

WARNING

THE FUEL SYSTEM IS UNDER PRESSURE.

WARNING

GASOLINE IS EXTREMELY FLAMABLE.

VALVE TRAIN INSPECTION & ADJUSTMENT

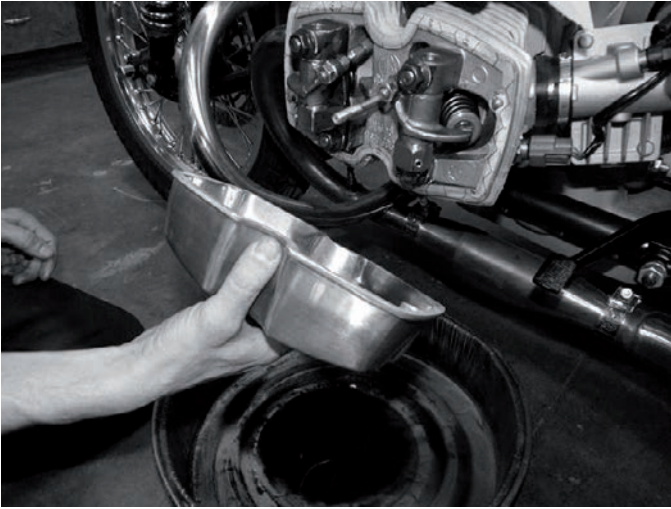

Step 1

Starting with the left side cylinder, remove the valve cover and clean any contaminants found inside with a shop towel.

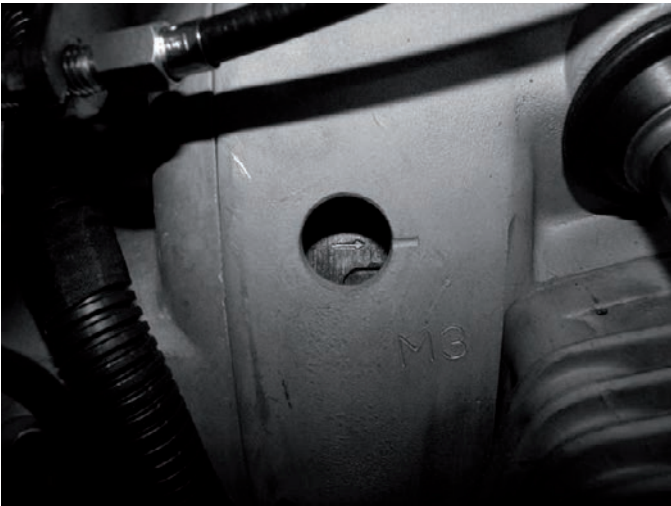

Step 2

Remove the timing plug located on the right side of the engine case. Slowly rotate the engine using the kick start lever until both valves are closed and the TDC (top dead centre) mark located on the flywheel is centered in the window.

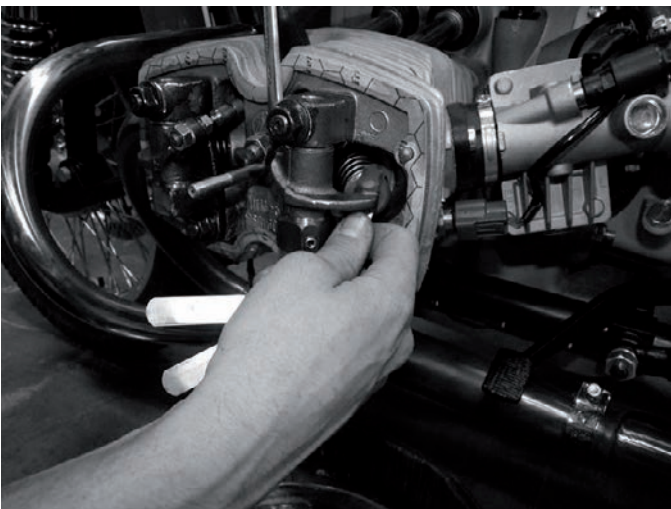

Step 3

Using a feeler gage check the free play on both valves to confirm they are within specifications.

VALVE TRAIN INSPECTION & ADJUSTMENT (CONT.)

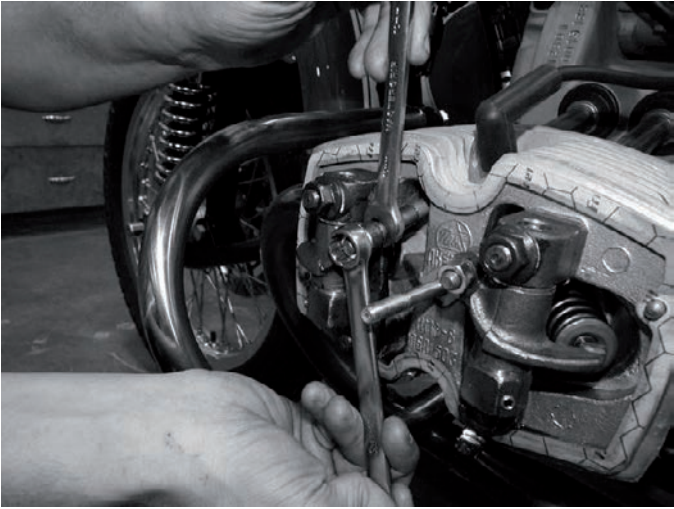

Step 4

If the free play clearance is not within specifications adjust as necessary. First loosen the jam nut and turn the adjustment bolt.

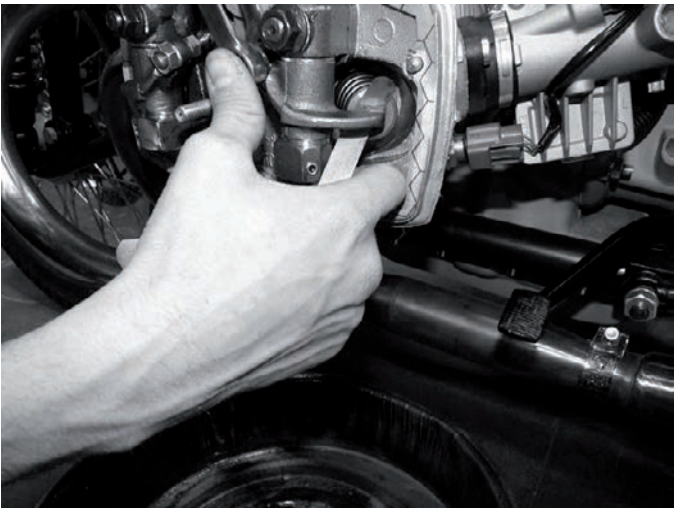

Step 5

After adjustment reconfirm the clearance is within specifications.

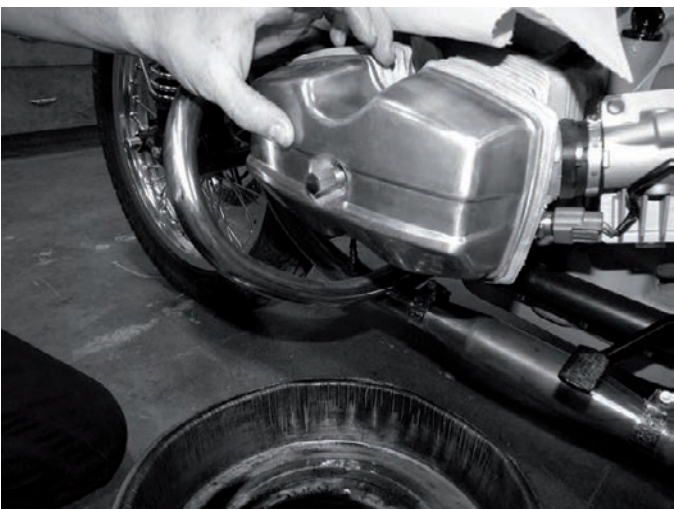

Step 6

Replace the valve cover gasket if needed and re-install the valve cover.

Step 7

Repeat the process on the right side by rotating the engine with the kick starter 360 degrees. Again, both valves will be closed and the TDC mark should be centered in the window.

CAUTION

OPERATING THE ENGINE WITH IMPROPERLY ADJUSTED VALVES CAN LEAD TO POOR PERFORMANCE AND POSSIBLE ENGINE DAMAGE.

FRONT BRAKE SYSTEM MAINTENANCE

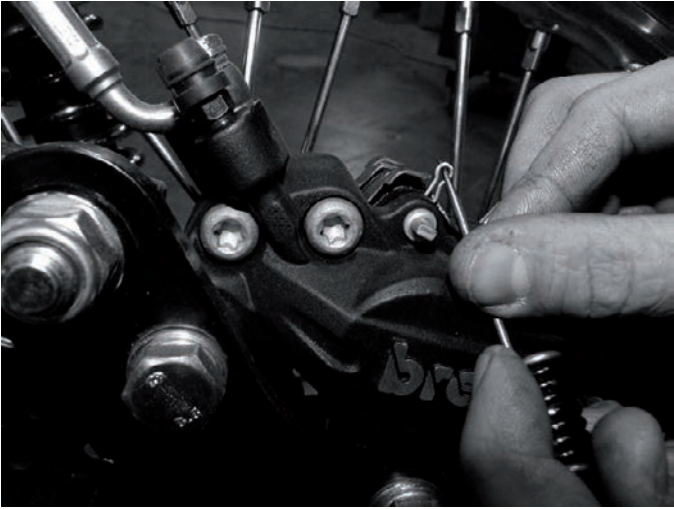

Step 1

Remove the retaining pin safety clips.

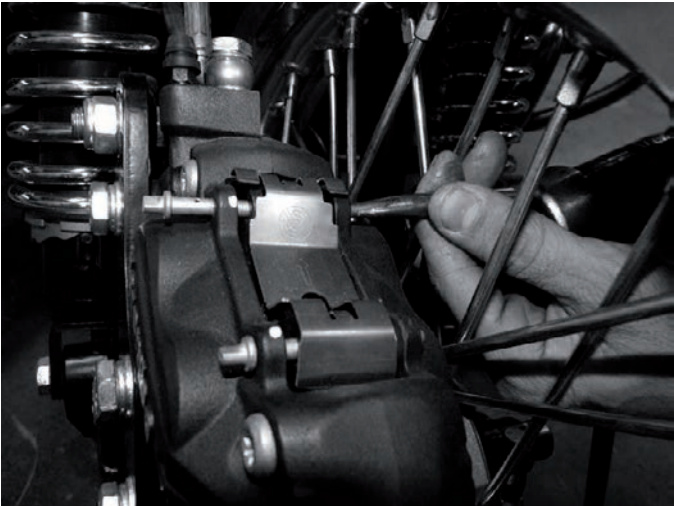

Step 2

Carefully drive the retaining pins out of the caliper using a small punch or drift.

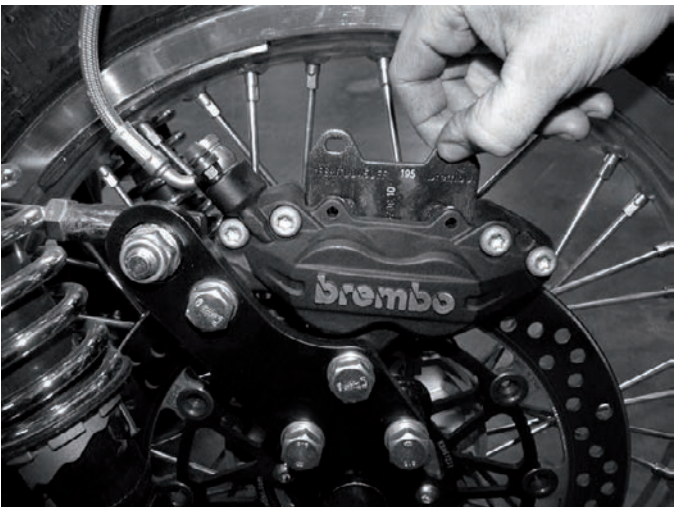

Step 3

Remove the brake pads by pulling them out the top of the caliper.

FRONT BRAKE SYSTEM MAINTENANCE (CONT.)

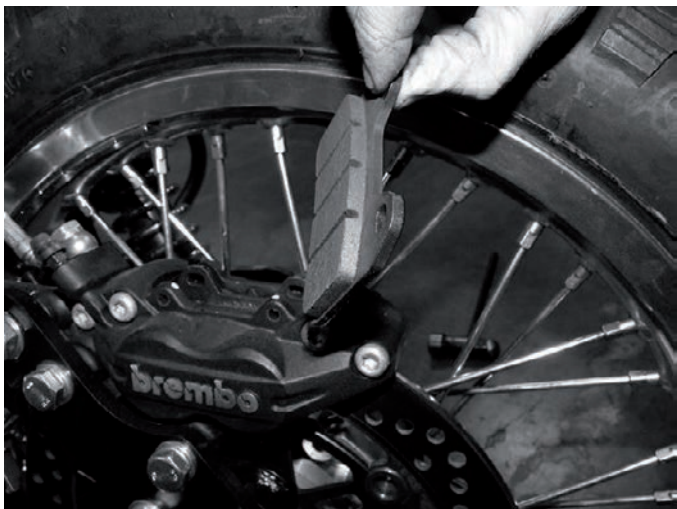

Step 4

Inspect the brake pads and replace as needed.

NOTE

MINIMUM PAD THICKNESS IS 1MM

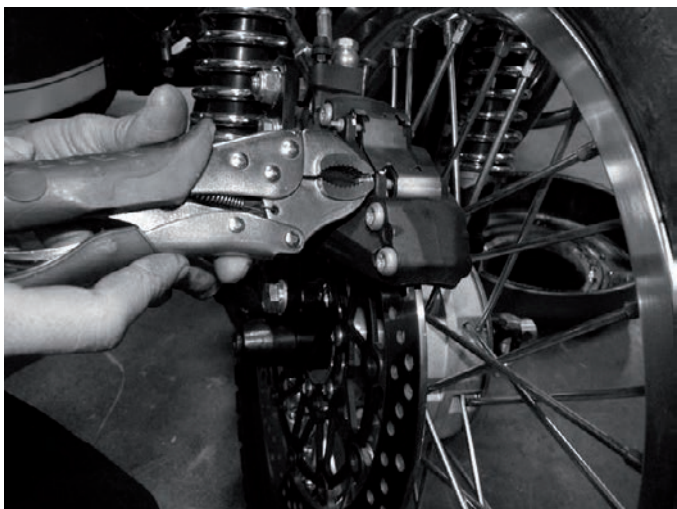

Step 5

Re-install brake pads in reverse order.

Be sure to fully seat the retaining pins and install the safety clips.

Step 6

Confirm the brake fluid level is full in the reservoir and add as needed to FULL line.

DO NOT OVER FILL

CAUTION

OPERATING THE MOTORCYCLE WITH WORN BRAKE PADS CAN CAUSE DAMAGE TO THE BRAKE ROTORS.

WARNING

OPERATING THE MOTORCYCLE WITH WORN BRAKE PADS BELOW THE MINIMUM THICKNESS CAN RESULT IN POOR BRAKING AND POSSIBLE ACCIDENT.

WARNING

OPERATING THE MOTORCYCLE WITH LOW FLUID LEVEL CAN CAUSE LOSS OF BRAKING FORCE.



REAR BRAKE SYSTEM MAINTENANCE

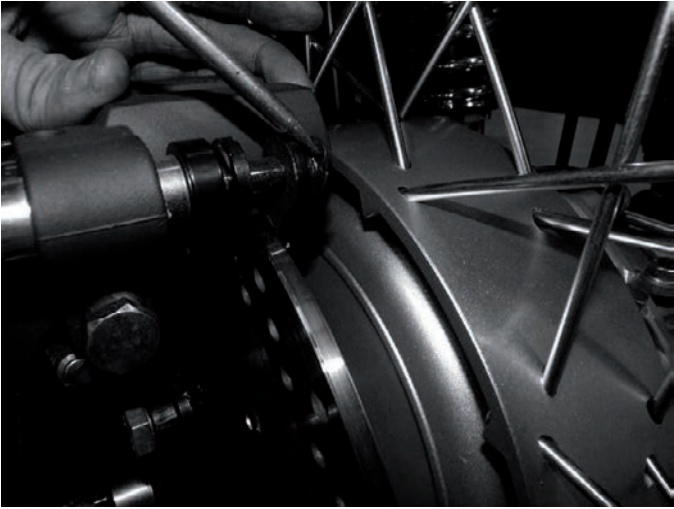

Step 1

Remove the caliper retaining bolt safety clips.



Step 2

Remove the caliper retaining bolts.

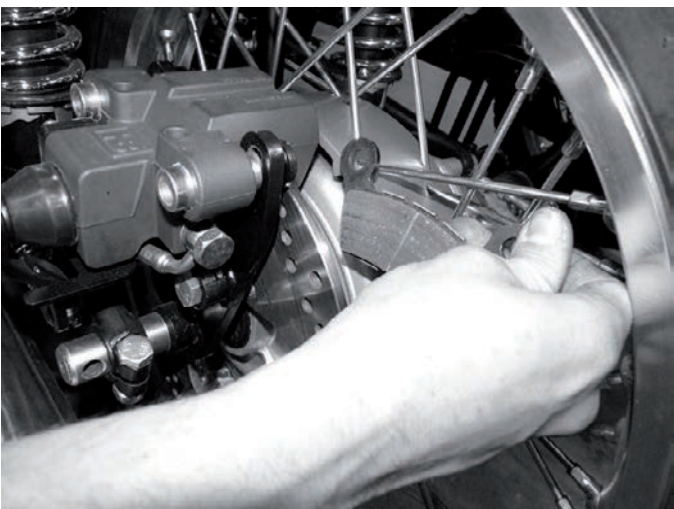

Step 3

Remove the brake pads by pulling to the rear of the motorcycle.

REAR BRAKE SYSTEM MAINTENANCE (CONT.)

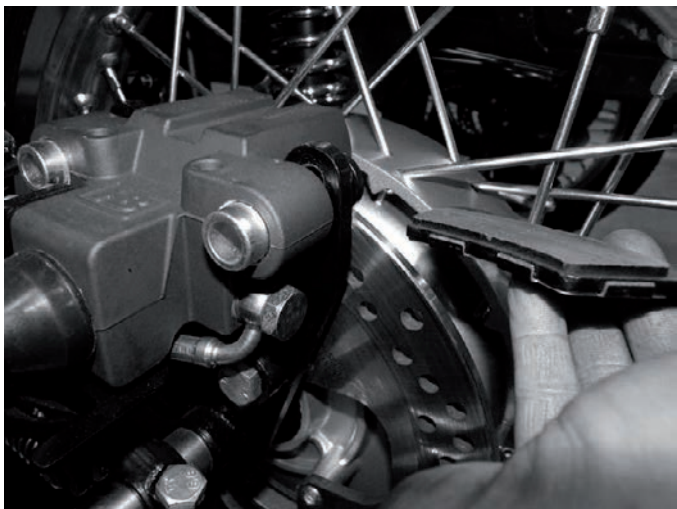

Step 4

Inspect the brake pads and replace as needed.

NOTE

MINIMUM PAD THICKNESS IS 1MM

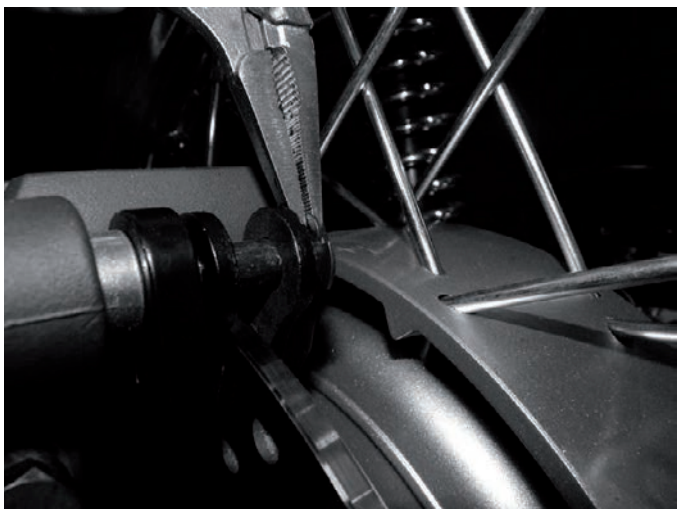

Step 5

Re-install brake pads in reverse order. **DO NOT** forget to install the safety clips.

Step 6

Confirm the brake fluid level is full in the reservoir and add as needed to FULL line.

DO NOT OVER FILL

CAUTION

OPERATING THE MOTORCYCLE WITH WORN BRAKE PADS CAN CAUSE DAMAGE TO THE BRAKE ROTORS.

WARNING

OPERATING THE MOTORCYCLE WITH WORN BRAKE PADS BELOW THE MINIMUM THICKNESS CAN RESULT IN POOR BRAKING AND POSSIBLE ACCIDENT.

WARNING

OPERATING THE MOTORCYCLE WITH LOW FLUID LEVEL CAN CAUSE LOSS OF BRAKING FORCE.

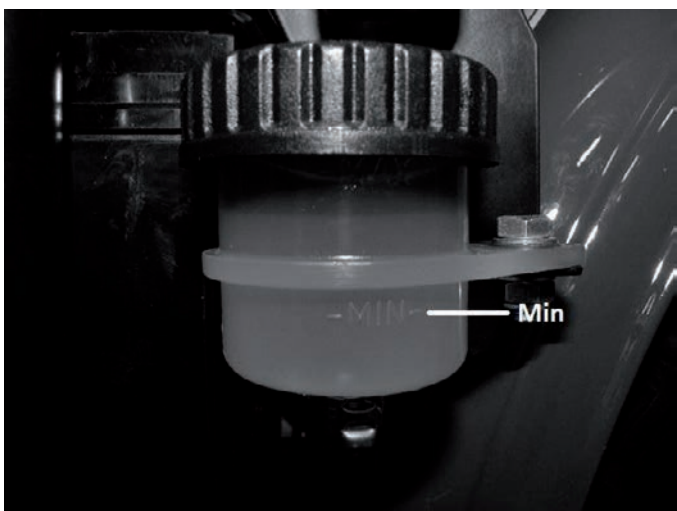

PARKING BRAKE ADJUSTMENT



Step 1

Locate the cable adjuster connected to the parking brake handle and be sure the parking brake is in the “off” position.

Step 2

Adjust the cable to remove excess free play.



NOTE

IF INCREMENTAL ADJUSTMENTS USING THE TOP ADJUSTMENT NUT DO NOT RETURN THE PARKING BRAKE TO NORMAL PERFORMANCE, RETURN THE TOP ADJUSTMENT NUT TO A FULLY SEATED (ZERO FREE PLAY) POSITION AND MAKE ADJUSTMENTS ON THE LOWER CABLE ADJUSTER TO REGAIN NORMAL OPERATION OF THE PARKING BRAKE.

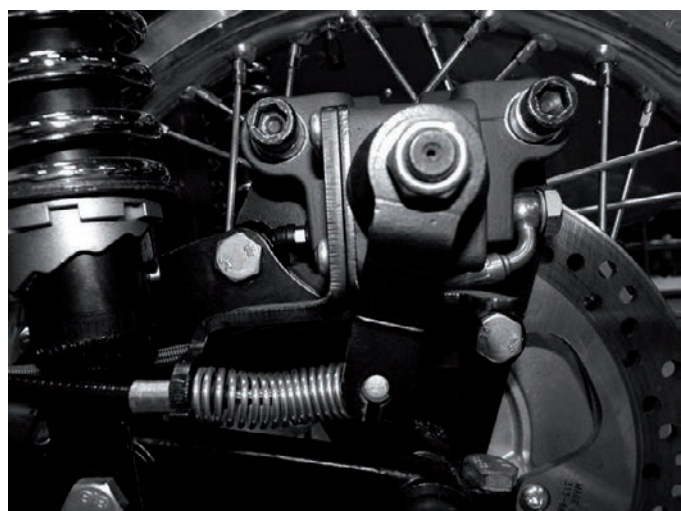

NOTE

WITH THE PARKING BRAKE SET YOU WILL HAVE APPROXIMATELY 12MM BETWEEN THE CALIPER STOP BRACKET AND THE BRAKE ARM WITH SPRING.

SIDECAR BRAKE SYSTEM MAINTENANCE

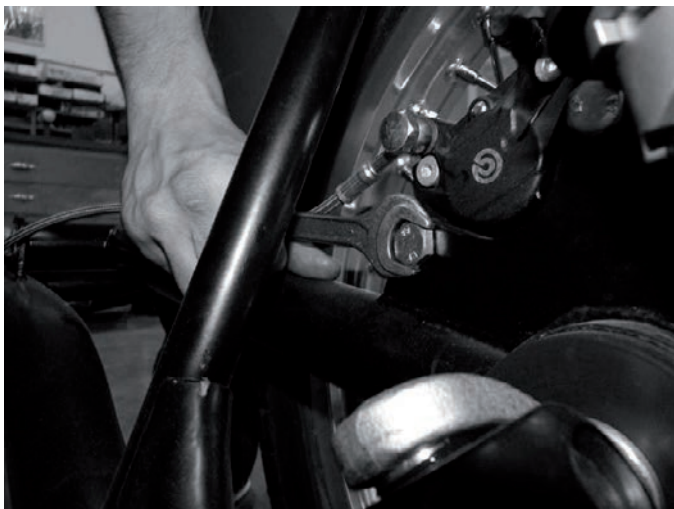

Step 1

Remove the caliper mounting bolts.



Step 2

Remove the caliper from the sidecar swing arm.



Step 3

Remove the caliper safety clip and carefully drive the retaining pin out of the caliper with a punch or drift.

SIDECAR BRAKE SYSTEM MAINTENANCE (CONT.)



Step 4

Remove the brake pads by pulling them out of the bottom of the caliper.



Step 5

Inspect the brake pads and replace as needed.

NOTE

MINIMUM PAD THICKNESS IS 1MM

Step 6

Re-install the brake pads and caliper in reverse order. **DO NOT** forget to install the safety clip.

Step 7

Confirm the brake fluid level is full in the reservoir and add as needed to **FULL** line.

DO NOT OVER FILL



CAUTION

OPERATING THE MOTORCYCLE WITH WORN BRAKE PADS CAN CAUSE DAMAGE TO THE BRAKE ROTORS.

WARNING

OPERATING THE MOTORCYCLE WITH WORN BRAKE PADS BELOW THE MINIMUM THICKNESS CAN RESULT IN POOR BRAKING AND POSSIBLE ACCIDENT.

WARNING

OPERATING THE MOTORCYCLE WITH LOW FLUID LEVEL CAN CAUSE LOSS OF BRAKING FORCE.

FRONT WHEEL REMOVAL & INSTALLATION

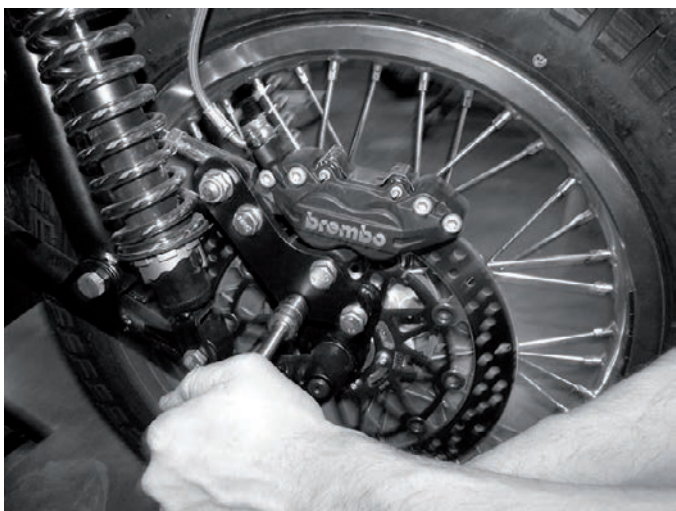

Step 1

Remove the lower caliper mounting bracket bolts.



Step 2

Carefully support the brake caliper using a strap.



Step 3

Loosen the axle pinch bolt.

FRONT WHEEL REMOVAL & INSTALLATION (CONT.)



Step 4

Loosen the axle by rotating clockwise and remove from the wheel.



Step 5

To re-install the wheel first place the caliper mount into the wheel.



Step 6

Position the wheel back on the bike and install the axle. DO NOT tighten fully at this point.

FRONT WHEEL REMOVAL & INSTALLATION (CONT.)



Step 7

Re-attach the caliper with mounting brackets and tighten to specification.



Step 8

Tighten the axle by rotating counter-clockwise.



Step 9

Tighten the axle pinch bolts to specification.

REAR WHEEL REMOVAL & INSTALLATION



Step 1

Place the motorcycle on the centre stand.

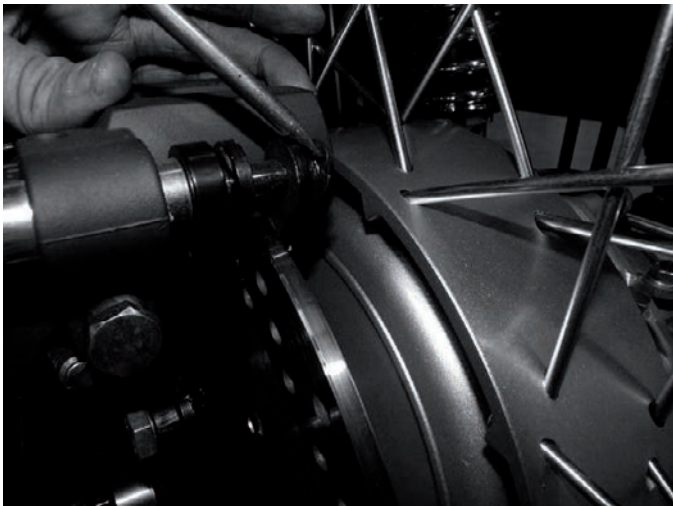

Step 2

Carefully remove the caliper retaining bolt safety clips.



Step 3

Remove the caliper retaining bolts and brake pads.

REAR WHEEL REMOVAL & INSTALLATION (CONT.)



Step 4

Support the brake caliper using a strap.

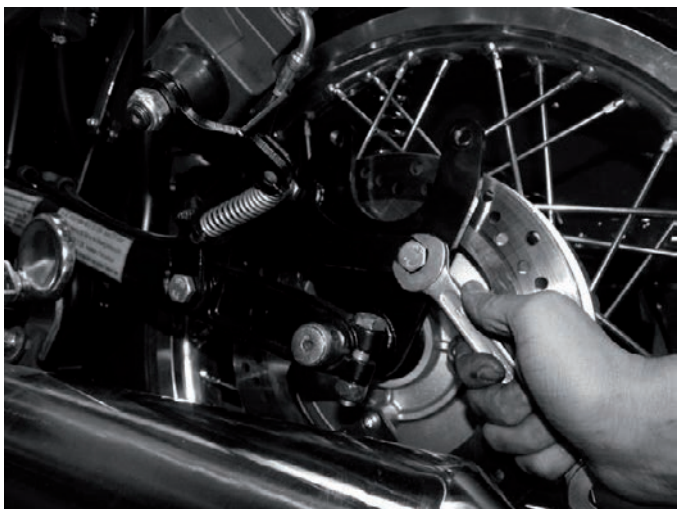

Step 5

Remove the brake caliper mounting bracket bolts. Swing the support brace bracket up.

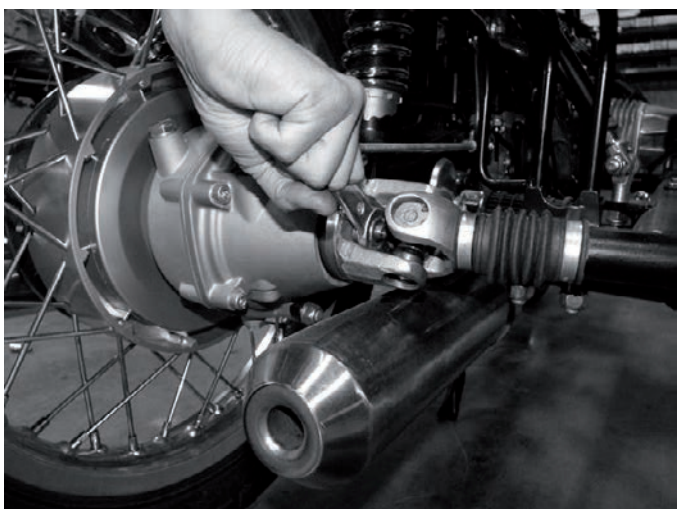

Step 6

Remove the rear axle nut.

REAR WHEEL REMOVAL & INSTALLATION (CONT.)

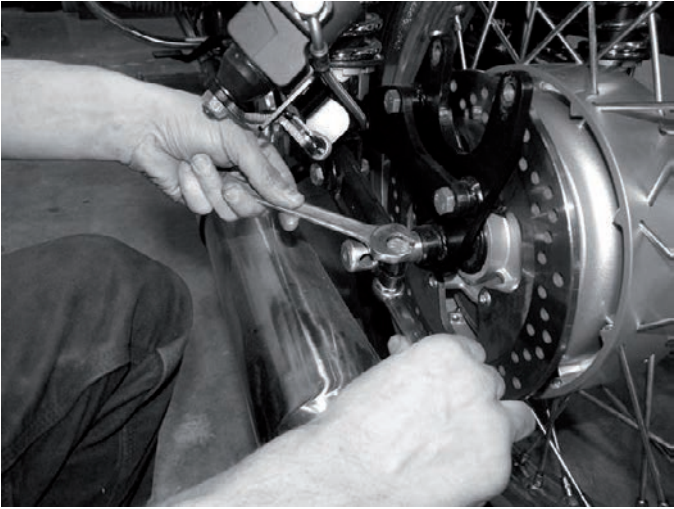

Step 7

Loosen the axle pinch bolt and remove the axle.

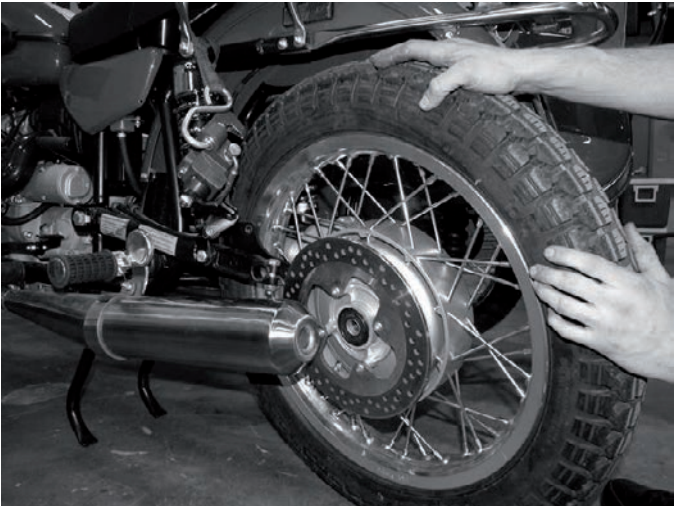

Step 8

Remove the rear wheel by tilting the outwards towards you and rolling it back as shown.

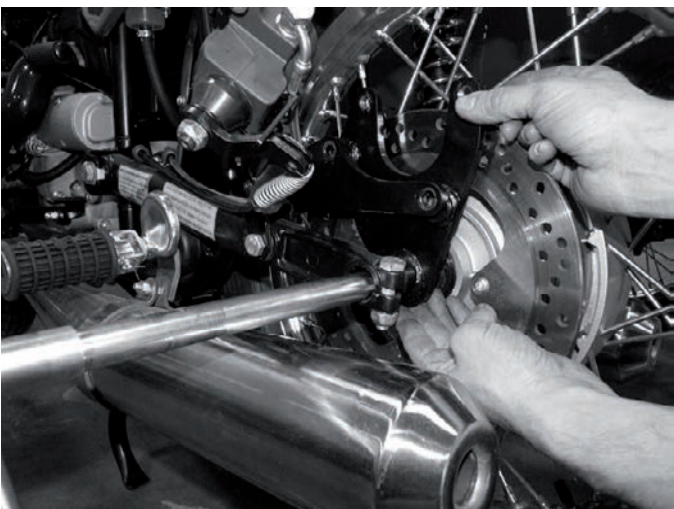

Step 9

To re-install the rear wheel place the wheel back on the bike and push the axle through both the wheel and brake mounting bracket as shown.

REAR WHEEL REMOVAL & INSTALLATION (CONT.)

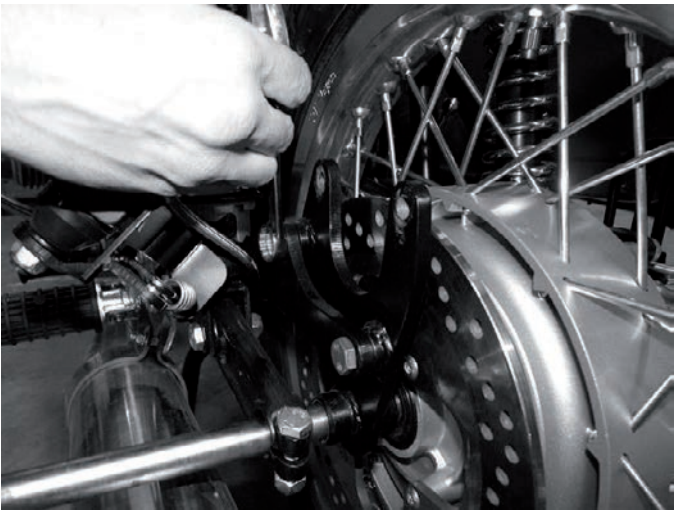

Step 10

Torque the caliper mounting bracket bolts to specification.



Step 11

Re-install the brake caliper and brake pads. Torque the caliper retaining bolts to specification.

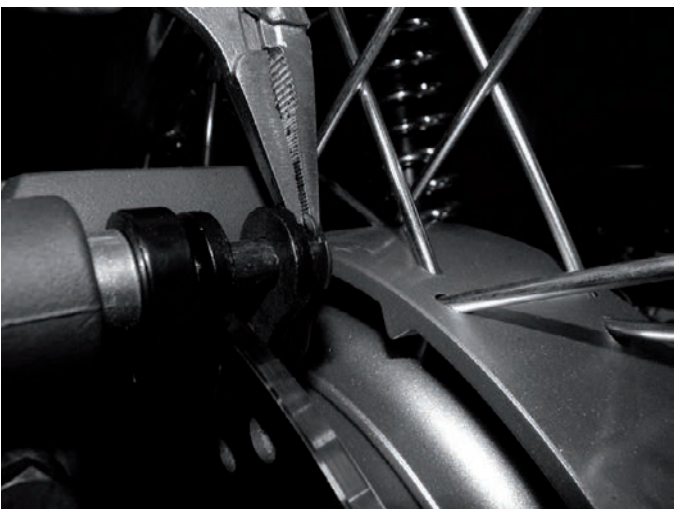

Step 12

Re-install the caliper retaining bolt safety clips.

SIDECAR WHEEL REMOVAL & INSTALLATION

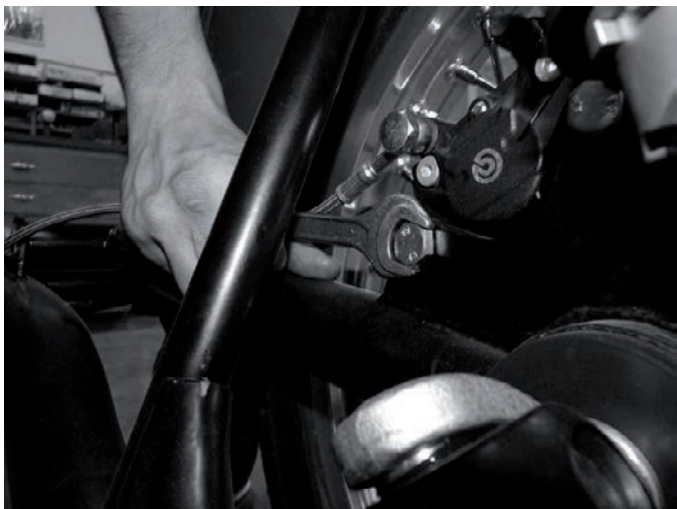

Step 1

Remove the sidecar brake caliper.



Step 2

Carefully remove the sidecar hub cap.



Step 3

Remove the axle cotter pin and axle nut.

Step 4

Re-install the sidecar wheel in reverse order.

USING THE SPARE WHEEL



WARNING

THE SPARE WHEEL IS INTENDED FOR USE ON THE REAR POSITION ONLY.

Step 1

Remove the rear wheel and rear brake rotor.

Step 2

Install the brake rotor on the spare wheel and torque to specification.

Step 3

Install the spare wheel on the motorcycle.

WHEEL SPOKE MAINTENANCE



The wheel spokes should be checked on a regular basis and per the maintenance intervals.

You check spoke tension by lightly tapping each spoke and listening to the ring. Loose spokes will make a low flat sound.

Step 1

Tap each spoke and compare the sound from one to another.

Step 2

Tighten spokes as needed. If spokes require more than $\frac{1}{2}$ turn to tighten you may need to remove the tyre and have the wheel professionally trued.



WHEEL BEARING REPLACEMENT & DIAGRAMS

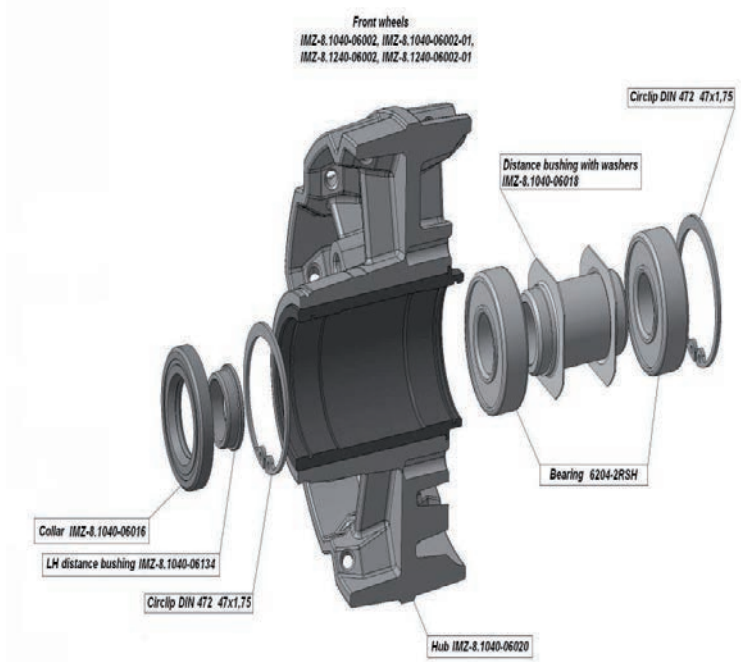

The wheel bearings are sealed type and cannot be service only replaced.

The bearings should be inspected and replaced per the maintenance intervals.

Step 1

Remove the wheel.

Step 2

Remove the dust seals and retaining clips.

Step 3

Carefully drive the bearings out of the hub and replace.

Step 4

Re-install in reverse order replacing the dust seals as needed.

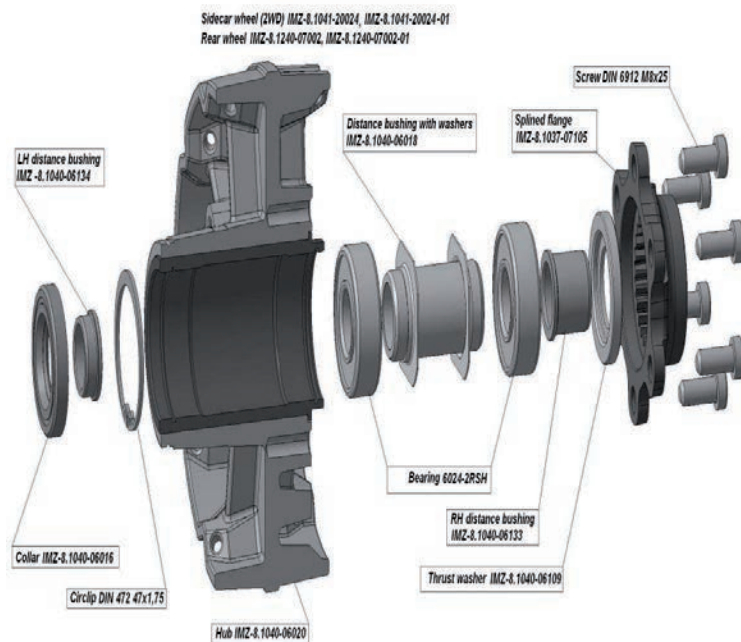

NOTE

WHEEL BEARINGS SHOULD BE INSPECTED AND REPLACED MORE FREQUENTLY THAN OUTLINED IN THE MAINTENANCE SCHEDULE WHEN THE MOTORCYCLE IS USED OFF ROAD OR IN ADVERSE WEATHER ON A REGULAR BASIS.

CAUTION

FAILURE TO REPLACE THE WHEEL BEARINGS WHEN NEEDED CAN DAMAGE THE WHEEL HUB AND AXLE.

WARNING

DAMAGED AND/OR WORN BEARINGS CAN PREVENT THE WHEEL FROM ROTATING FREELY.

TYRE & TUBE REPLACEMENT

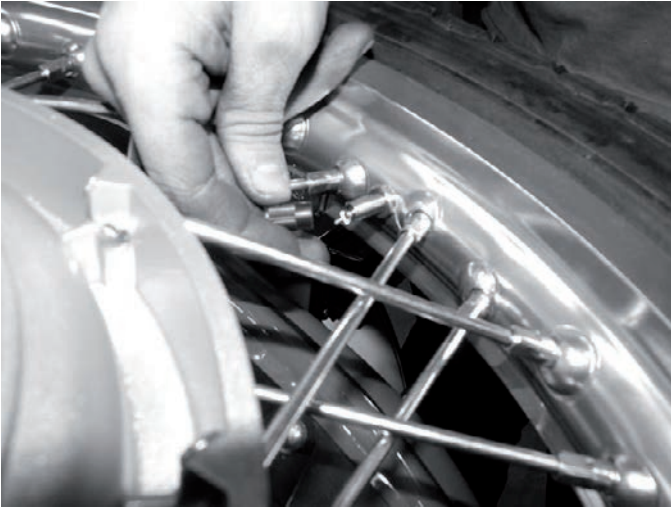

Step 1

Remove the valve stem and deflate the tyre.



Step 2

Using the provided tyre spoons in your tool kit carefully remove one side of the tyre from the rim.



Step 3

Remove the tube from the tyre.

Step 4

Remove the tyre from the rim.

Step 5

Re-install the tyre in reverse order; be careful not to pinch the tube during installation.

NOTE

WHEN INFLATING THE TYRE, BE SURE THE TYRE BEAD IS FULLY SEATED AND EVEN AROUND THE RIM.
--

SIDECAR ALIGNMENT

The sidecar should be installed in a definite position relative to the motorcycle. The position is determined by the camber and toe-in of the motorcycle and the sidecar wheels. An incorrectly aligned sidecar will drag the motorcycle to either side and cause extensive tyre wear. If the motorcycle is not stable on the road or is difficult to steer, check the alignment. Checking and measuring the alignment should be done on level ground.

Check toe-in of the motorcycle and the sidecar wheels with two straight bars applied to the side faces of the wheels just below the axles. The toe-in should be 3 to 8mm (2wd models) or 8 to 12mm (1wd models) at the front wheel. When adjusting, unbolt the top of the strut legs fastening the sidecar to the motorcycle, loosen the bolt clamping the lower rear bracket, and adjust the position of the bracket relative to the rear tube of the sidecar frame to obtain necessary toe-in of the wheels. Tighten up the bolt fastening the bracket, adjust the length of the strut legs and secure them with bolts.

Check the lean-out of the motorcycle using a level gauge or protractor with a plumb bob and a ruler; standard lean-out is 1-2 degrees. Adjust the two inclined legs by screwing the forks in or out. When the lean-out is correct, the rider will remain vertical while riding on the local roads which may be slightly sloped to assist with water runoff.

Check the toe-in while the motorcycle is running on the road. With the toe-in properly adjusted, the motorcycle will not pull to either side while running at normal road speed. If it pulls to the right, increase the toe-in, if it pulls to the left, decrease the toe-in.

CAUTION

DOUBLE CHECK FOR CORRECT TOE-IN BEFORE MAKING ANY CHANGE TO LEAN-OUT.

SIDECAR ALIGNMENT DIAGRAM

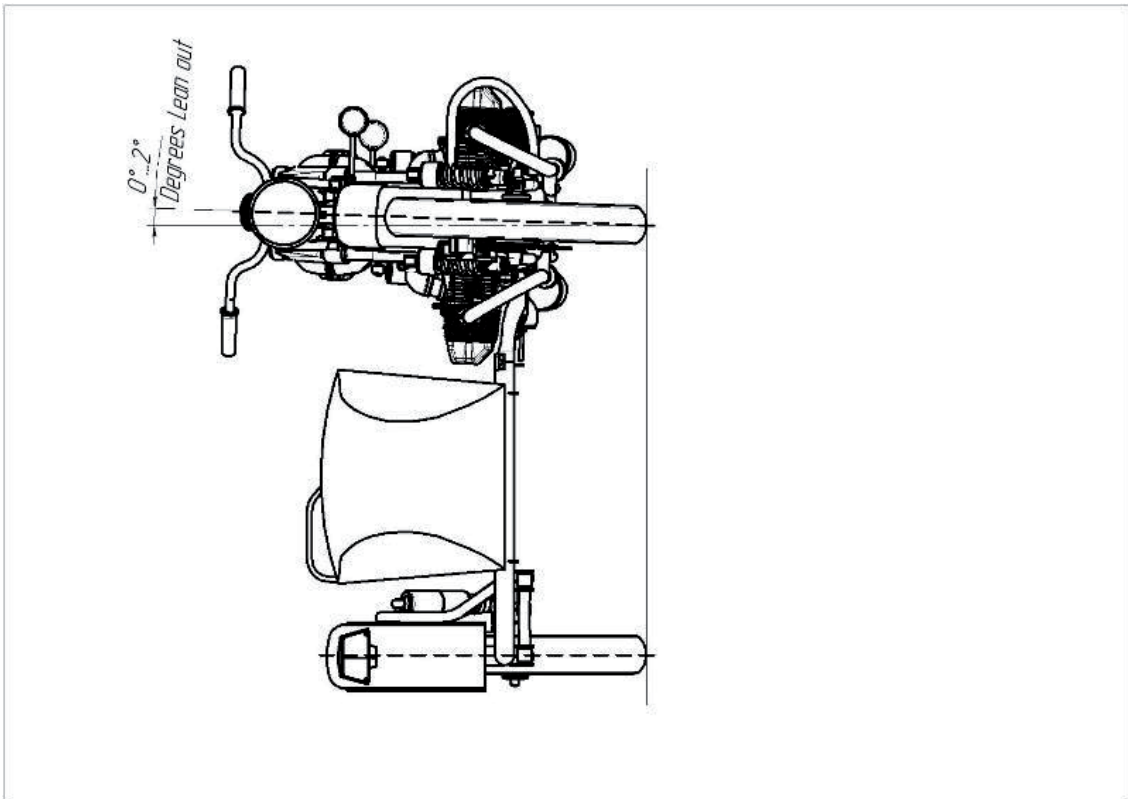
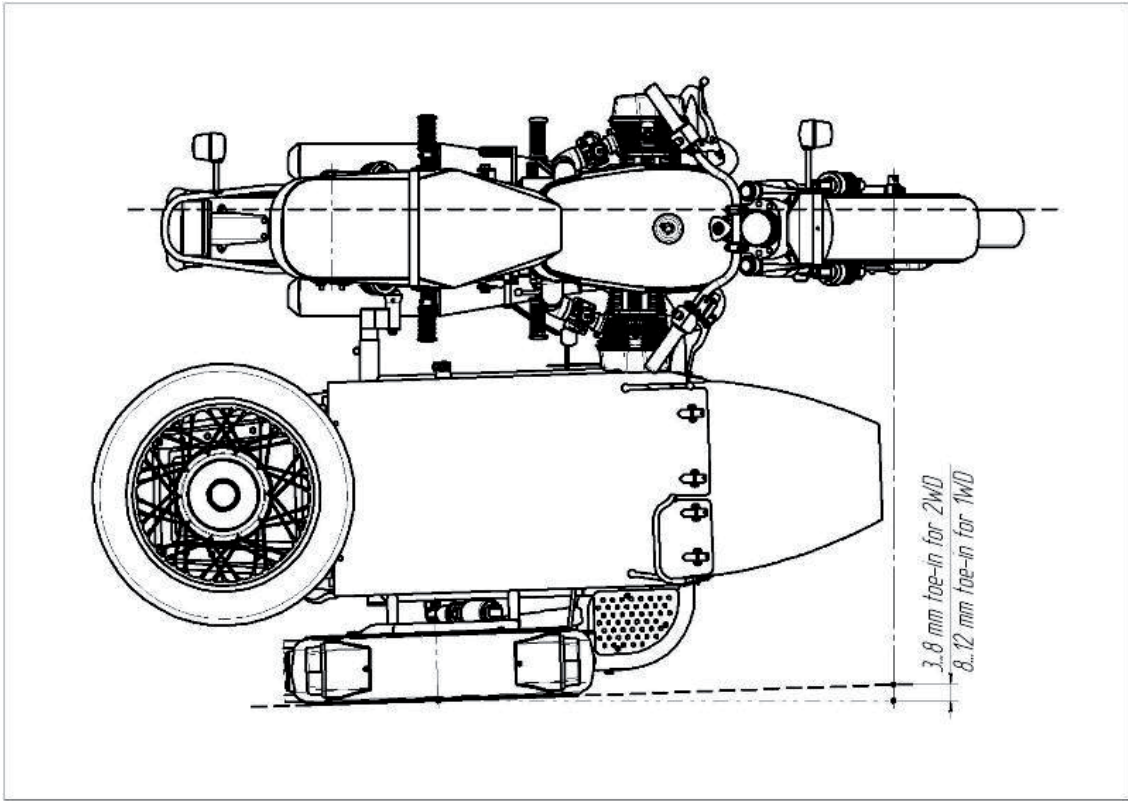

6. Electrical

	Page
Lamp & Bulb Replacement	6-2
Battery Maintenance & Replacement	6-6
Fuse & Relay Locations	6-9
Sidecar Fuse & Relay Locations	6-10
Starter	6-11
Alternator	6-11
ECU Data Port	6-11

LAMP & BULB REPLACEMENT (HEADLIGHT)

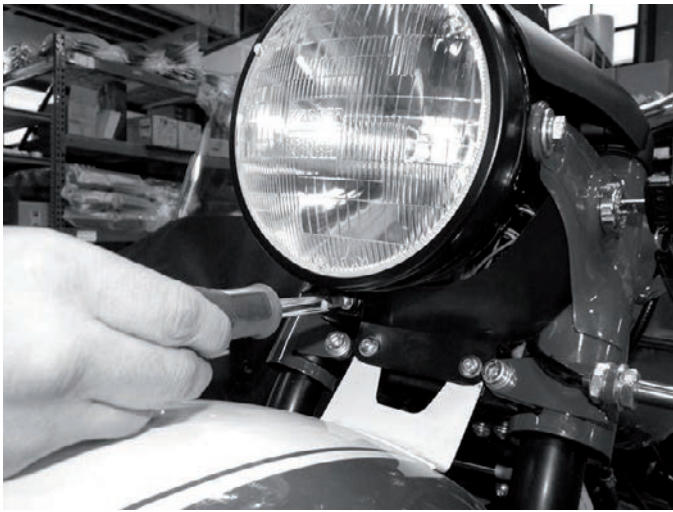

Headlight Replacement

Step 1

Remove the lamp retaining ring screw and pull the lamp out of the bucket.

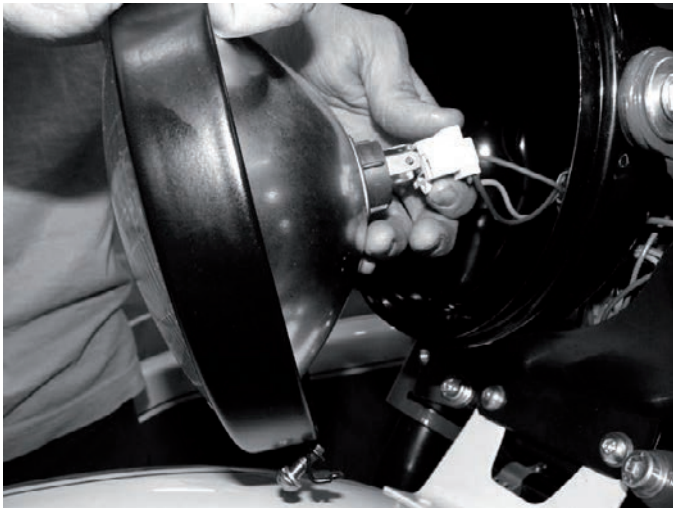

Step 2

Disconnect the lamp.



Step 3

Carefully remove the lamp retaining clips and replace lamp.

Step 4

Re-install in reverse order.

WARNING

ALWAYS WEAR EYE PROTECTION WHEN REMOVING LAMP RETAINING CLIPS.

WARNING

IT IS UNSAFE TO OPERATE YOUR MOTORCYCLE WITHOUT A FUNCTIONING HEADLIGHT.

LAMP & BULB REPLACEMENT (TAIL LIGHT)



Tail Light Replacement

Step 1

Remove the tail light lenses retaining screws.



Step 2

Inspect and replace bulbs as needed.

The upper bulb in the running/brake lamp and the lower is the license plate lamp.

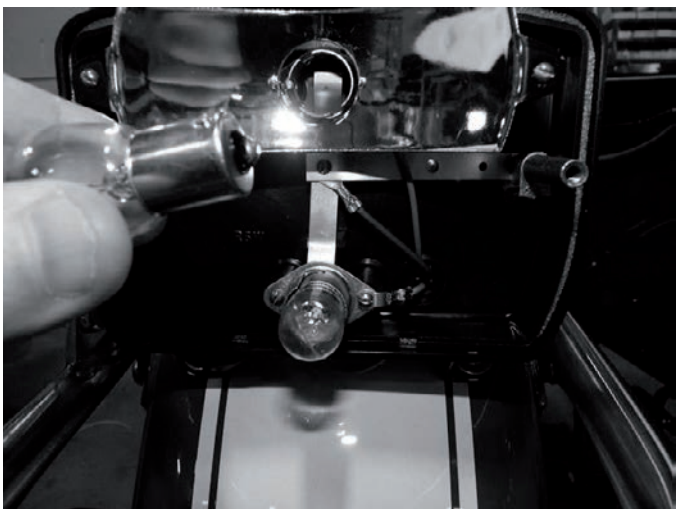

Step 3

To remove the bulb twist and pull.

Step 4

Re-install the bulbs in reverse order.

NOTE

TO HELP PREVENT CORODED CONTACTS USE DIELECTRIC GREASE.

WARNING

IT IS UNSAFE TO OPERATE YOUR MOTORCYCLE WITHOUT A FUNCTIONING TAIL AND BRAKE LIGHT.

LAMP & BULB REPLACEMENT (TURN SIGNALS)



Turn Signal Bulb Replacement

Step 1

Remove the turn signal lenses retaining screws.

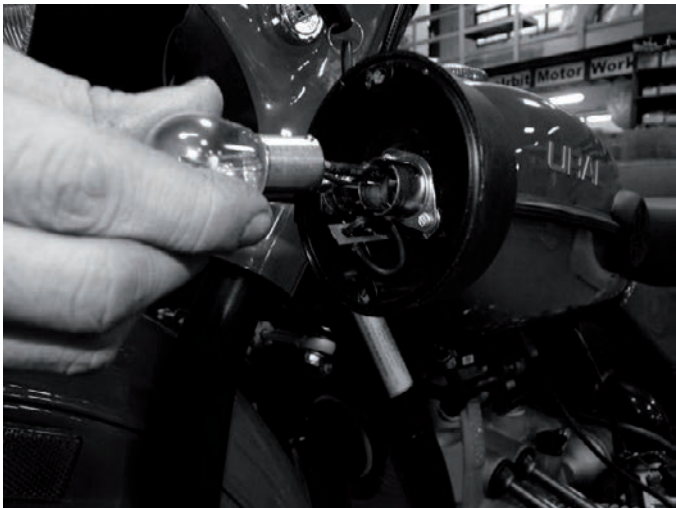

Step 2

Inspect and replace bulbs as needed.

Step 3

To remove the bulb twist and pull.

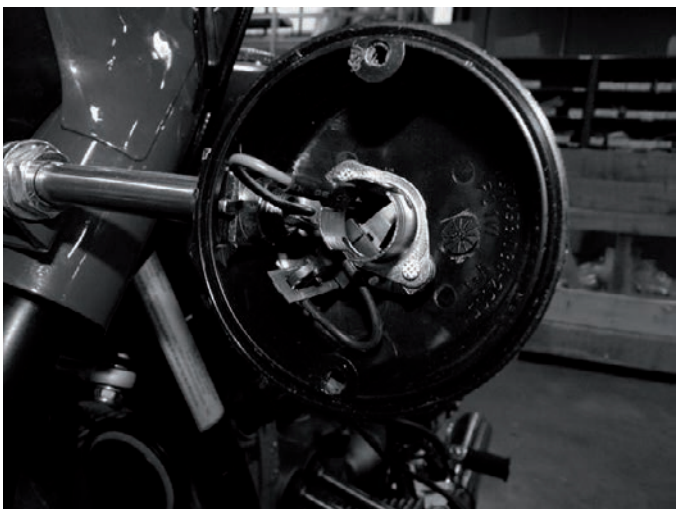

Step 4

Re-install the bulbs in reverse order.

NOTE

TO HELP PREVENT CORRODED CONTACTS USE DIELECTRIC GREASE.

WARNING

IT IS UNSAFE TO OPERATE YOUR MOTORCYCLE WITHOUT FUNCTIONING TURN SIGNALS.

LAMP & BULB REPLACEMENT (SIDECAR LAMPS)



Sidecar Lamps

Step 1

Remove the lenses retaining screws.

Step 2

Inspect and replace bulbs as needed.



Step 3

To remove the bulb twist and pull.

Step 4

Be sure to re-install the lenses gasket.



Step 5

Re-install the bulbs in reverse order.

NOTE

TAIL LIGHT/BRAKE ON LEFT AND SIGNAL ON RIGHT

NOTE

TO HELP PREVENT CORRODED CONTACTS USE DIELECTRIC GREASE.

WARNING

IT IS UNSAFE TO OPERATE YOUR MOTORCYCLE WITHOUT FUNCTIONING SIDECAR LAMPS.

BATTERY MAINTENANCE

Stock battery on the motorcycle should function at ambient air temperature from -40°C to plus 60°C/ 40°F to 140°F.

As the battery is in service:

- Regularly check the voltage for 13.8 - 14.2 V
- Do not allow the battery to discharge.
- Coat bolts, nuts, washers and tips with petroleum jelly or battery grease. Use two wrenches for clamping or undoing the nuts to avoid breaking battery parts.

Before storage, fully charge the batteries, wash the battery surface with water and wipe dry, clean the bolts and nuts of dirt.

WARNING

BATTERIES CONTAIN SULFURIC ACID WHICH CAN CAUSE SEVERE BURNS. AVOID CONTACT WITH SKIN, EYS OR CLOTHING.

ANTIDOTE

EXTERNAL – FLUSH WITH WATER.

INTERNAL – DRINK LARGE QUANTITIES OF WATER FOLLOWED BY MILK OF MAGNESIA, VEGETABLE OIL, OR BEATEN EGGS.

CALL DOCTOR IMMEDIATELY

CAUTION

WHEN CHARGING THE BATTERY, DISCONNECT THE NEGATIVE TERMINAL FROM THE BATTERY TO PREVENT DAMAGE TO ELECTRICAL COMPONENTS.

NEVER JUMP START THE MOTORCYCLE!

WARNING

BATTERIES PRODUCE EXPLOSIVE HYDROGEN GAS AT ALL TIMES – ESPECIALLY WHEN BEING CHARGED. KEEP ANY OPEN FLAMES AND/OR SPARKS AWAY FROM THE BATTERY AT ALL TIMES. ALWAYS PROTECT HANDS AND FACE WHEN WORKING ON AND/OR NEAR A BATTERY.

KEEP BATTERIES OUT OF REACH OF CHILDREN AND PETS!

BATTERY REPLACEMENT



Step 1

Disconnect the white negative (-) battery cable.



Step 2

Disconnect the positive (+) battery cable

Step 3

Remove the battery hold down straps.

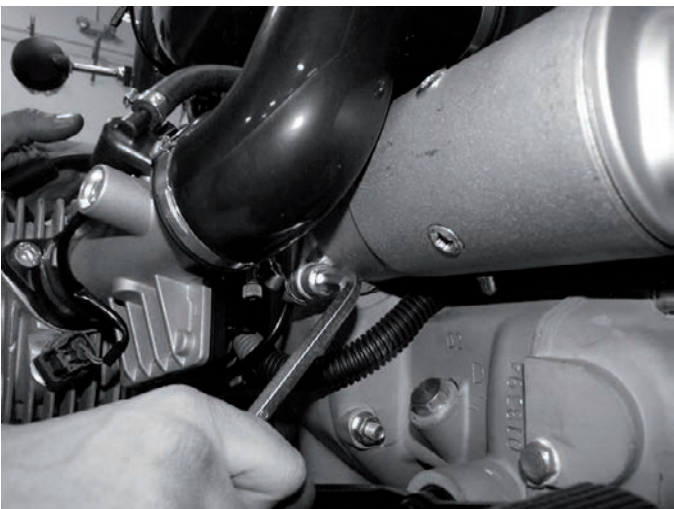

Step 4

Loosen both the upper and lower starter bolts to allow clearance for battery removal.

CAUTION

ALWAYS DISCONNECT THE NEGATIVE (-) BATTERY CABLE FIRST TO AVOID SHORTING THE BATTERY.

WARNING

SHORTING THE BATTERY TERMINALS COULD RESULT IN A FIRE.

BATTERY REPLACEMENT (CONT.)



Step 5

Carefully slide the battery out between the frame tube and air box.

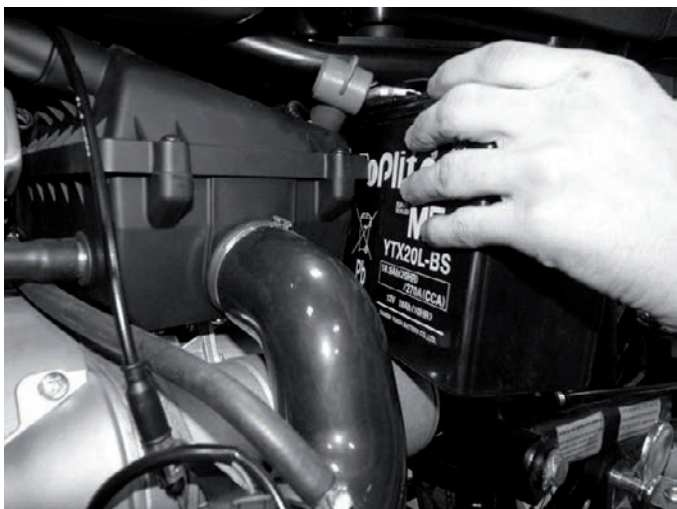

Step 6

Re-install in reverse order by sliding the battery back into place and reconnecting all straps and cables.

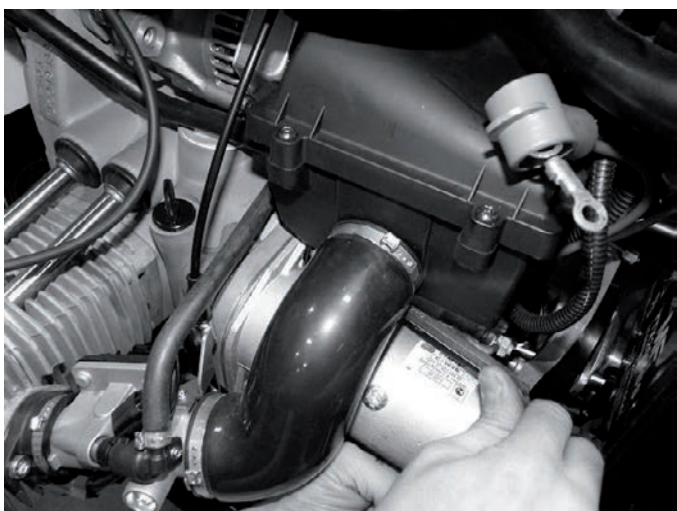

Step 7

Be sure to re-tighten the starter bolts.

CAUTION

ALWAYS RECONNECT THE POSITIVE (+) BATTERY CABLE FIRST TO AVOID SPARKS.

NOTE

USE DIELECTRIC GREASE ON THE BATTERY CONNECTIONS TO PREVENT CORROSION.

FUSE & RELAY LOCATIONS

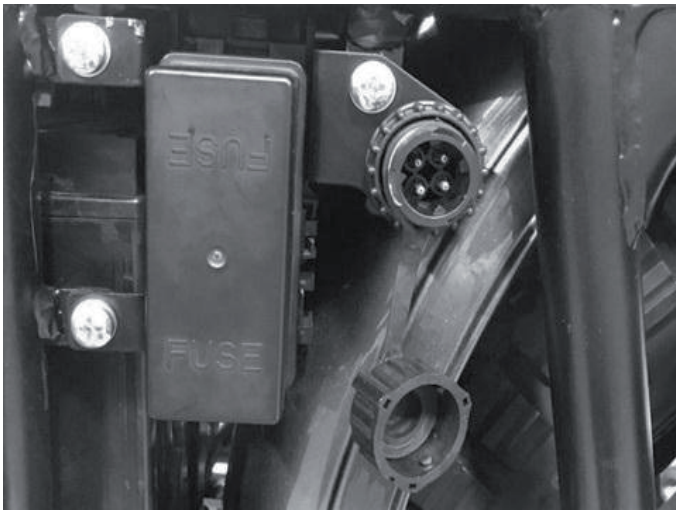

Fuse Box Main

The main motorcycle fuse box is located under the left side panel.

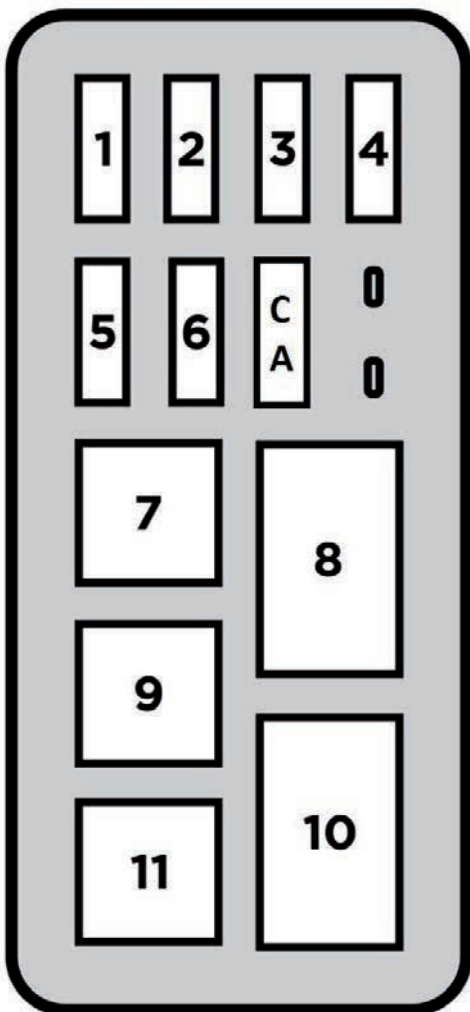

Fuse Box Diagram

This diagram shows the position and function for each fuse and relay in the fuse box.

1. ECU Power	10a
2. ECU Relay Power	15a
3. Ignition/Starter/Signals	15a
4. Brake Lights/Horn/EVAP	15a
5. Lights/High Beam	15a
6. Parking Lights	15a
CA. EVAP Emissions	10a
7. Headlight Relay	
8. ECU Relay	
9. Starter Lock-out Relay	
10. Lighting Relay	
11. Starter Relay	

FUSE & RELAY LOCATIONS (CONT.)

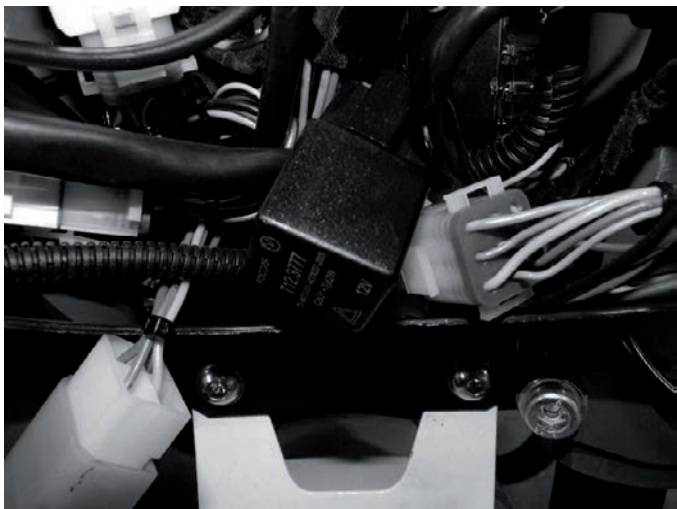

Turn Signal Relay

The turn signal relay is located behind the headlight bucket. To access this relay you must first remove the headlight bucket assembly.

SIDECAR FUSE & RELAY LOCATIONS

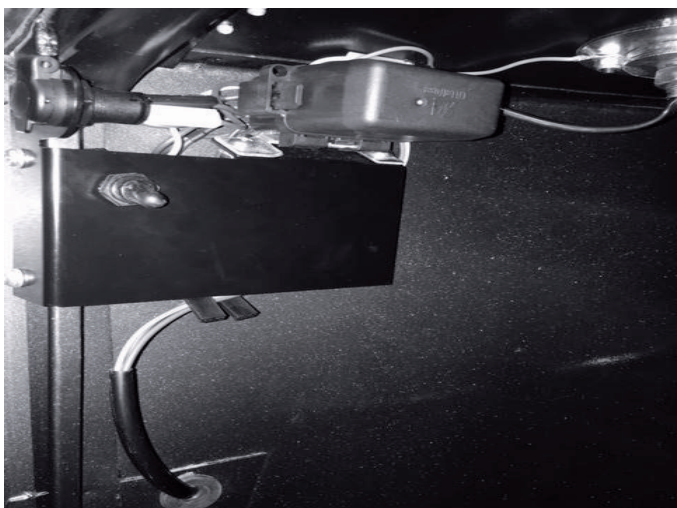

Fuse Box Sidecar

The sidecar fuse box is located on the left hand interior body panel of the sidecar.

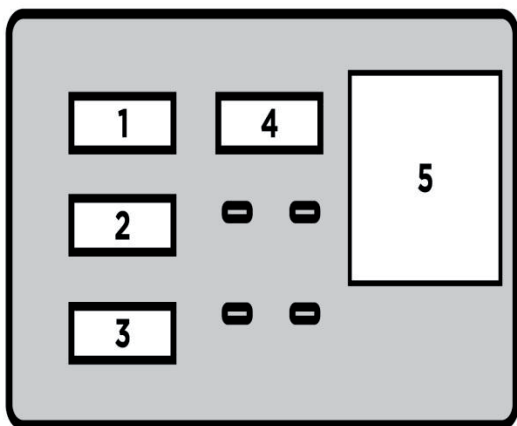

Fuse Box Diagram

This diagram shows the position and function for each fuse and relay in the fuse box.

- | | |
|---------------------|-----|
| 1. Power Outlet | 15a |
| 2. Accessory Switch | 15a |
| 3. Accessory | 15a |
| 4. Spotlight | 15a |
| 5. Spotlight Relay | |

ELECTRIC STARTER

The starter must provide 300-400 rpm to start the engine and requires a well maintained battery. If battery is below required voltage the electric starter may not operate efficiently. If the battery becomes low you may need to use the kick starter.

ALTERNATOR

This motorcycle is equipped with a Denso Alternator.

Specifications:

Rated Voltage 12V

Rated Output 40A, 480W

Peak Output 560W @ 14V

Testing the Alternator on the Motorcycle

If no test bench is available, check the output of the alternator with the engine running.

- Connect the voltmeter to positive and negative terminals of the storage battery
- Start the engine
- While starting the voltage will drop to as low as 9.5 V
- At 3500-4000 rpm output voltage should be 13.5-14.5 VDC

In the course of daily inspection, check the fastening of wires to the alternator terminals and fastening of the alternator on the engine crankcase.

ECU DATA PORT

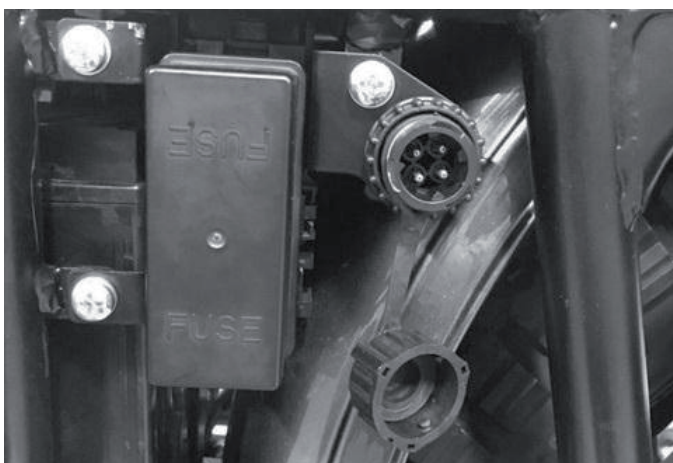

The ECU Data port is located behind the left side panel. This data port is intended for:

DEALER ONLY EFI DIAGNOSTICS

The data port has a protective cap that should be left in place to prevent debris from contaminating the connector.

7. EFI Troubleshooting

	Page
Engine Management (MIL Blink Codes)	7-2
Service Notes	7-4

URAL ENGINE MANAGEMENT SYSTEM BLINK DIAGNOSTICS

Introduction

A basic blink code system has been implemented on the Ural EFI bikes to aid EMS (Engine Management System) diagnostics without the need for an additional computer diagnostic tool, greatly helping the user when during travels. When activated, the MIL (malfunction indicator lamp) blinks out a code sequence relating to the fault. This document is intended as a quick reference guide as supplemental information to the EMS Service Manual.

Operation

When the MIL is continuously lit with the key on, an EMS fault has occurred. With the key on and engine off, toggle the kill switch three times within a two second timeframe to initiate the blink sequence. Three changes are required, not three complete kill-run cycles. For example, if the switch is in engine kill state, the sequence would be "Kill -> Run -> Kill -> Run" with the '->' indicating a flick of the switch.

The MIL will now blink a code sequence corresponding with the EMS's diagnosed fault. Each code has a three digit sequence, with each digit having a value of 1-5. A short pause occurs between individual digits, while a long pause between repeating the code or displaying the next code, depending on the number of fault events.

To identify the fault, initiate the blink sequence, and count out blinks for each of the three digits. Writing down the pattern helps. The light will blink on half second intervals for each digit. Between each digit, a one second pause will occur. Between each blink code, or the repetition of the code if a single fault is present, a three second pause exists. When a fault presents a specific component on the vehicle system, the component must be inspected, along with electrical connections and harness components leading up to the component. This will aid in diagnosing and fixing the problem.

The blink sequence will continue to repeat until the function is deactivated. To deactivate the feature, toggle the kill switch three times within a two second time-frame, the same as to activate the feature.

Fault Category

The first digit is used to indicate the category of fault. This helps to identify if the problem is specific to one ECU or to the vehicle as a whole. These categories are defined as follows:

First Digit Value	Category	Description
1	Cylinder 1 Faults	Faults specific to the left EMS
2	Cylinder 2 Faults	Faults specific to the right EMS
3	System Faults	Vehicle level EMS faults

Blink Code	Category	Sub-Category	Fault Description	Action
111 / 211	Cylinder 1 / 2	Internal CPU	Cal CRC mismatch	See Dealer
112 / 212	Cylinder 1 / 2	Internal CPU	EEPROM Failure	See Dealer
113 / 213	Cylinder 1 / 2	Internal CPU	Program Error	See Dealer
121 / 221	Cylinder 1 / 2	Internal ECU	MAT Sensor Failure	See Dealer
122 / 222	Cylinder 1 / 2	Internal ECU	BAP Sensor Failed	See Dealer
123 / 223	Cylinder 1 / 2	Internal ECU	BAP Comm. Failure	See Dealer
124 / 224	Cylinder 1 / 2	Internal ECU	MAP Failure	See Dealer
125 / 225	Cylinder 1 / 2	Internal ECU	MC33814 Failure	See Dealer
131 / 231	Cylinder 1 / 2	INJ or IGN	INJ open or short to ground	Check wires to injector
132 / 232	Cylinder 1 / 2	INJ or IGN	INJ short to battery	Check wires to injector
133 / 233	Cylinder 1 / 2	INJ or IGN	IGN open or short to ground	Check wires to ignition coil
134 / 234	Cylinder 1 / 2	INJ or IGN	IGN short to battery	Check wires to ignition coil
141 / 241	Cylinder 1 / 2	O2 or O2 Heater	O2 Sensor Circuit Failed Low	Check O2 sensor
142 / 242	Cylinder 1 / 2	O2 or O2 Heater	O2 Sensor Circuit Failed High	Check O2 sensor
143 / 243	Cylinder 1 / 2	O2 or O2 Heater	O2 Heater open or short to ground	Check wires to O2 sensor
144 / 244	Cylinder 1 / 2	O2 or O2 Heater	O2 Heater short to battery	Check wires to O2 sensor
151 / 251	Cylinder 1 / 2	Other	Engine Temperature Sensor fault	Check temperature sensor
311	System	Battery	High Voltage	Inspect vehicle battery
312	System	Battery	Low Voltage	Charge or replace battery
313	System	Battery	Unstable Voltage	Inspect charging system
321	System	Fuel Pump / Pres.	Pump open or short to ground	Check wires to fuel pump
322	System	Fuel Pump / Pres.	Pump short to battery	Check fuel pump
323	System	Fuel Pump / Pres.	Pressure Sensor failed	Check fuel pump
331	System	VCOM	VCOM A Failed	Check ECU harness
341	System	Immobilizer	LED open or short to ground	Check wires to LED
342	System	Immobilizer	LED short to battery	Check wires to LED

SERVICE NOTES

8. Warranty Information

	Page
Warranty Agreement	8-2
Warranty Disclaimers	8-3

URAL MOTORCYCLES LIMITED WARRANTY

Ural Motorcycles warrants to the first retail purchaser of the URAL motorcycle from an authorised dealer and each subsequent owner that the motorcycle is free from defects in materials and workmanship for the period stated below.

To Qualify For This Warranty

- The URAL® motorcycle must be purchased from a dealer within Australia or New Zealand who is authorised by Ural Australia to sell motorcycles (see www.imz-ural.com.au for a complete list of authorised dealers).
- Prior to delivery to the purchaser, the dealer who is authorised by Ural Australia to sell motorcycles must perform the complete set-up and pre-delivery procedures.

Warranty Time Period for Current Model Year

- Duration of Ural Motorcycles Limited Warranty is 24 months, starting from the date the motorcycle is sold to the first retail purchaser and the warranty registration card is received by Ural Australia
- There is no mileage limitation.
- Any unexpired portion of this limited warranty will be transferred to subsequent owners, upon the resale of the motorcycle during the limited warranty period.

Warranty Coverage

- To obtain warranty service, return your motorcycle at your expense within the limited warranty period to an authorised Ural dealer. The authorised Ural dealer should be able to provide warranty service during normal business hours, depending upon the workload of the authorised dealer's service department and the availability of necessary parts.
- Ural Australia will repair or replace, at its options, any part (including parts of the emission control systems) that are found to be defective in material or workmanship under normal use for the applicable time period.
- In cases when warranty repair takes longer than 14 days, the warranty time period (see Warranty Time Period) is extended for the period of time required to complete the repairs, during which the motorcycle could not be ridden.
- Ural Australia will reimburse non-URAL repair shops performing warranty repairs only if all the warranty processing and approval procedures are completely fulfilled and/or carried out according to Ural Australia's guidelines (see Warranty Claim Filing Procedures).

WARRANTY DISCLAIMERS LIMITATIONS & EXCLUSIONS

Ural Australia Disclaims Any Responsibility For:

- Loss of time due to warrantable issues and/or repairs.
- Loss of use of motorcycle due to warrantable repairs.
- Transportation expenses including, but not limited to, towing and/or rentals.
- Any other incidental or consequential damages and/or expenses.

THERE IS NO OTHER EXPRESSED WARRANTY (OTHER THAN THE SEPARATE EMISSIONS LIMITED WARRANTIES) ON THE MOTORCYCLE.

Any implied warranty of merchantability or fitness for particular purpose is limited to the duration of the express warranty, or to the duration set forth in your state's warranty statutes, whichever is shorter.

State Laws May Vary

The previous listed limitations or exclusions may not apply to a motorcycle because of state laws. Some states may not allow limitations on how long an implied warranty lasts. Some states may not allow exclusion or limitation of incidental or consequential damages.

These Warranties Do Not Cover:

1. Failures or required services that is not due to a defect in material or factory workmanship
2. Parts or accessories affected or damaged by:
 - Lack of required maintenance
 - Owner abuse
 - Accident and/or collision
 - Misuse
 - Normal wear
 - Neglect
 - Improper installation
 - Unsuitable use in an application for which the part was not designed
 - The incorporation or use of unsuitable attachments or parts
 - The unauthorized alteration of any part or system
 - Deterioration from the elements
 - Failure to follow running-in (break-in) procedure
3. Replacement of expendable maintenance items including, but not limited to:
 - Spark plugs
 - Filters
 - Lubricants
 - Compliance fittings (throttle body mounting flanges)
 - Tires
 - Gaskets
 - Fuel line
 - Fuses
 - Bulbs
 - Battery (after 1 year in service)
4. Paint and/or decal fading, peeling, blistering, chipping or rusting.
5. Surface rust or corrosion on the chassis and/or drivetrain.

The Following Activities Will VOID Warranty Coverage:

- Any operation or use outside of that described in Owner's Manual
- Racing
- Competition
- Rental and/or other commercial use
- Alteration of the odometer reading
- Towing

Dealer's Warranty Responsibilities:

- Thoroughly check and road test new units before delivery.
- Complete and send Warranty Registration and Card of Delivery to Ural Australia within 3 business days of the sale of motorcycle.
- Accept all eligible motorcycles for warranty service regardless of selling dealer.
- Keep records of all warranty work.
- Attend service schools and annual dealer meetings as provided by Ural Australia.
- Submit warranty claims to Ural Australia within 10 business days of the repair date.
- Send failed parts and/or parts assemblies for an inspection to Ural Australia within 3 (three) business days upon Ural Australia's request at Ural Australia's shipping expense.
- Provide digital pictures of failed and/or defective parts and assemblies with all claims.

Owner's Warranty Responsibilities:

- As the owner of Ural motorcycle, you are responsible for the performance of the required maintenance listed in your owner's manual. URAL recommends that you retain all receipts covering maintenance on your motorcycle, but URAL cannot deny warranty solely for the lack of receipts or for your failure to ensure the performance of all scheduled maintenance.
- You are responsible for presenting your motorcycle to an URAL dealer as soon as a problem exists. The warranty repairs should be completed in a reasonable amount of time not to exceed 30 (thirty) days.
- As the motorcycle owner, you should also be aware that URAL may deny you warranty coverage if your motorcycle or a part has failed due to abuse, neglect, improper maintenance or unapproved modifications.

SPARE PARTS AND ACCESSORIES WARRANTY

Ural Motorcycles provides limited warranty for spare parts and accessories for the following period of time starting from the time of purchase of the parts by a dealer or retail customer:

- Engine – 12 months
- Gearbox – 12 months
- Final drive – 12 months
- Alternator – 6 months
- Starter – 6 months
- EFI Components – 6 months
- All other parts and accessories - 30 days

The above applies ONLY in cases when a dealer or retail customer identifies defects before using parts and/or accessories or these defects are identified during use AND provided these parts and/or accessories have been properly installed by Ural Motorcycles or an authorized Ural dealer.

9. Emission Control Information

	Page
Crankcase Emission Diagram	9-2

CRANKCASE EMISSION DIAGRAM

CLOSED CRANKCASE:

No crankcase emissions will be discharged directly into the ambient atmosphere throughout the useful life by any vehicle to be covered by EPA Certification.

Crankcase exhaust emitted by the timed breather is routed to the air filter box and ends prior to the filter. The crankcase exhaust is recycled through the air filter and inducted back into the engine.

Please see the diagram below:

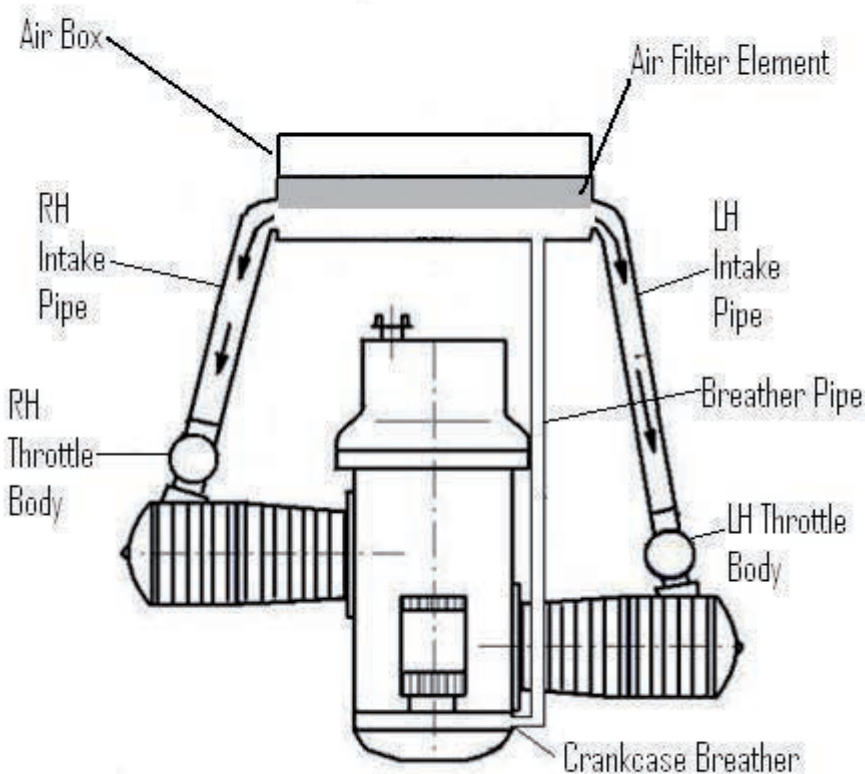

NOTE

IT IS AGAINST FEDERAL LAW TO TAMPER WITH OR REMOVE EMISSION RELATED COMPONENTS.

10. Owner's Documents

New Owner Form
New Address Form
Training Rebate Form

Intentionally left blank

Intentionally left blank



NEW ADDRESS FORM

If you move, please fill out the form and mail to the address below. This will insure that you continue to receive all correspondence from Ural Australia.

VEHICLE IDENTIFICATION NUMBER

OWNER'S NAME _____

OLD ADDRESS _____

CITY _____ STATE _____ POSTCODE _____

MY NEW ADDRESS IS:

NEW ADDRESS _____

CITY _____ STATE _____ POSTCODE _____

Mail this form to:

Ural Australia Pty Ltd
119 Bridge Street
Uralla NSW 2358

Or fax to: (02) 6778 4673

****We never sell or rent your personal information to third parties unaffiliated with Ural.**

Intentionally left blank

11. Schematics

Wiring Diagram

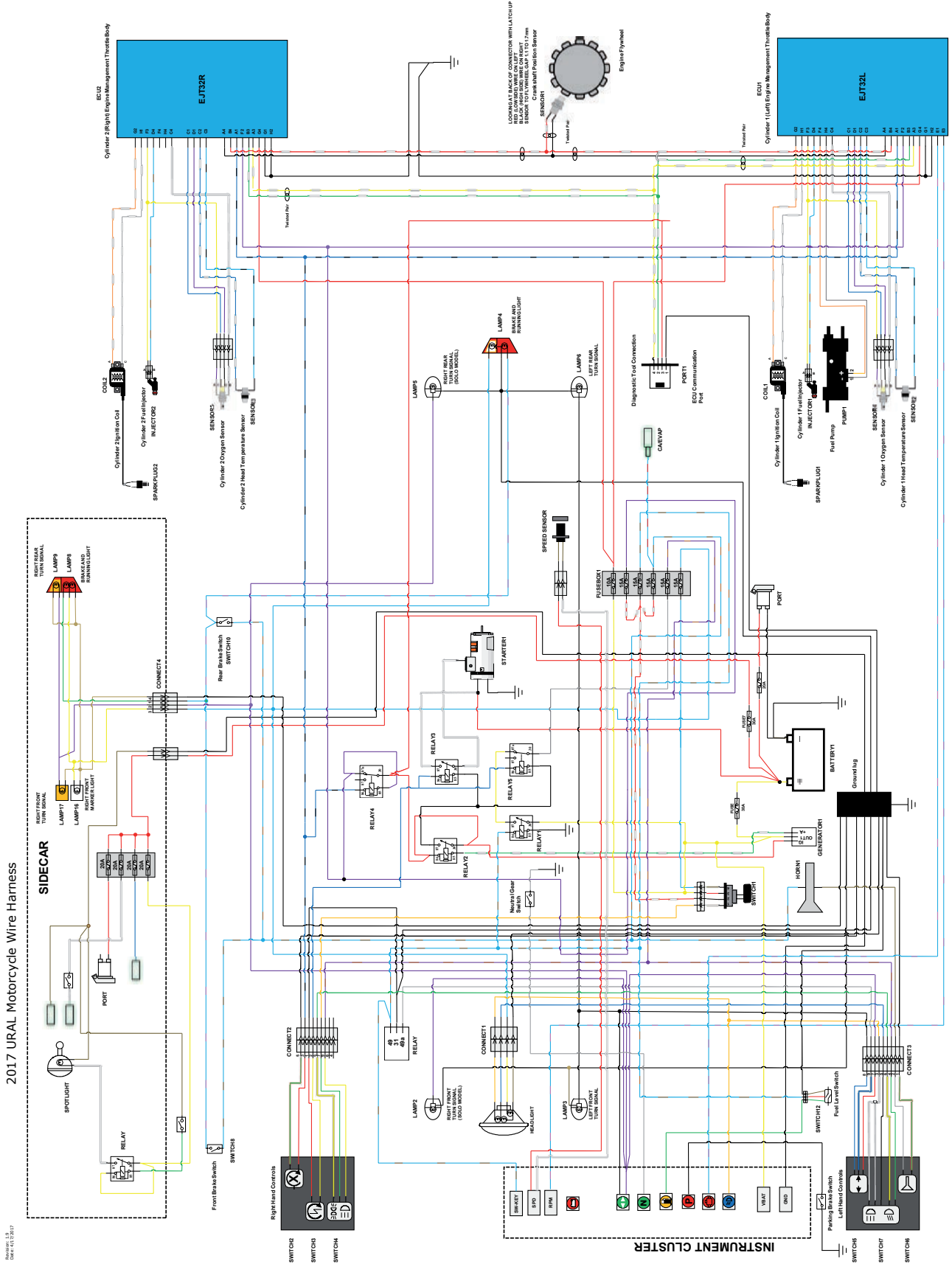

For current wiring schematics, please visit Ural Motorcycles website at

www.imz-ural.com



IMZ-URAL.COM